

**ASD →**  
**»→ BANHEIRAS**  
**BATHTUBS**



**aśd**  
Banho

ASD →  
⇒ BANHEIRAS  
ACESSÓRIOS

**Banheiras - Bathtubs**

4	<u>Charme Canto</u>
8	<u>Charme</u>
12	<u>Clássica Duo</u>
16	<u>Clássica</u>
24	<u>Planíssima Canto</u>
30	<u>Planíssima Duo</u>
34	<u>Planíssima</u>
40	<u>Elegance</u>
44	<u>Tília</u>
48	<u>Tulipa</u>
52	<u>Gardénia</u>
56	<u>Camélia</u>
60	<u>Sistemas - Systems</u>

**Freestanding**

66	<u>Becool</u>
68	<u>Oval</u>
70	<u>Tendence</u>
72	<u>Art Epoque</u>

**Torneiras - Taps**

74	<u>Torneiras - Taps</u>
84	<u>Colunas - Columns</u>
98	<u>Acessórios - Accessories</u>

**Técnico - Technical**

100









## CHARME → → CANTO

Banheira Charme de Canto equipada com sistema de hidromassagem eletrónico Flat em latão cromado, com opção 7 microjatos, sistema de desinfecção automática e lâmpada de iodo; Almofada em poliuretano integral skin preto; Conjunto torneira Extraplana; Pannel acrílico branco 1500x500.

Corner bathtub Charme equipped with Flat electronic whirlpool system in chromed brass, optional 7 micro jets, automatic disinfection system and spa light; Headrest in black integral skin polyurethane; Extraplana bath deck mixer; White acrylic panel 1500x500.

*Joaquim Camarinha*

Design: Arq. Joaquim Camarinha

-  Pés de apoio banheira  
Bathtub support feet
-  Almofada poliuretano preta  
Black headrest
-  Torneira de encastrar em banheira  
Bath deck mixer
-  Válvula descarga automática  
Automatic discharge valve

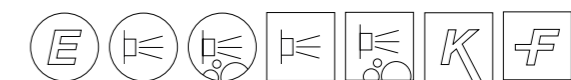

CHARME →  
 ⇒ CANTO



B ↓ A →

1300x1300

1350x1350

1400x 1400

1450x1450

1500x1500

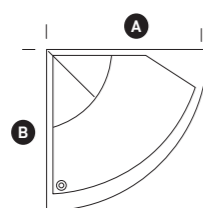

	1300	1350	1400	1450	1500
Banheira acrílica simples branca White acrylic bathtub	06021710130	06021710135	06021710140	06021710145	06021710150
Pés de apoio para banheira Bathtub support feet	KT060206	KT060206	KT060207	KT060207	KT060208
Painel acrílico branco White Acrylic Panel	0801051013050	0801051013550	0801051014050	0801051014550	0801051015050
Almofada poliuretano preta - Black headrest				522304	.
Válvula descarga automática - Automatic discharge valve				071001	.
Montagem de torneira de cliente - Customer tap assembly			99MONTORNEIRA		.
Torneira de encastrar em banheira - Bath deck mixer			<b>Consultar página - See page: 76 - 78</b>		

Dados técnicos - Technical data - P100

Tabela de preços → Price-list

Sistema ABS - ABS system Banheira branca/ jatos cromados White bathtub/ chromed jets	1300	1350	1400	1450	1500	
	<b>6 Jatos água</b>	26E16001710130	26E16001710135	26E16001710140	26E16001710145	26E16001710150
	<b>6 + 3 micros</b>	26E16031710130	26E16031710135	26E16031710140	26E16031710145	26E16031710150
	<b>6 + 5* micros</b>	26E16XX1710130	26E16XX1710135	26E16XX1710140	26E16XX1710145	26E16XX1710150
Ecoline Ecoline	<b>6 + 7 micros</b>	26E16071710130	26E16071710135	26E16071710140	26E16071710145	26E16071710150
	<b>6 Jatos água</b>	26416001710130	26416001710135	26416001710140	26416001710145	26416001710150
	<b>6 + 3 micros</b>	26416031710130	26416031710135	26416031710140	26416031710145	26416031710150
	<b>6 + 5* micros</b>	26416XX1710130	26416XX1710135	26416XX1710140	26416XX1710145	26416XX1710150
	<b>6+7 micros</b>	26416071710130	26416071710135	26416071710140	26416071710145	26416071710150
	<b>6 Jatos água</b>	26616001710130	26616001710135	26616001710140	26616001710145	26616001710150
	<b>6 + 3 micros</b>	26616031710130	26616031710135	26616031710140	26616031710145	26616031710150
	<b>6 + 5* micros</b>	26616XX1710130	26616XX1710135	26616XX1710140	26616XX1710145	26616XX1710150
	<b>6 + 7 micros</b>	26616071710130	26616071710135	26616071710140	26616071710145	26616071710150
	<b>6 Jatos água + 10 jatos ar</b>	2651610001710130	2651610001710135	2651610001710140	2651610001710145	2651610001710150
	<b>6 + 10 + 3 micros</b>	2651610031710130	2651610031710135	2651610031710140	2651610031710145	2651610031710150
	<b>6 + 10 + 5* micros</b>	265161XX1710130	2651610XX1710135	2651610XX1710140	2651610XX1710145	2651610XX1710150
	<b>6 + 10 + 7 micros</b>	2651610071710130	2651610071710135	2651610071710140	2651610071710145	2651610071710150
	<b>6 Jatos água + 10 jatos ar</b>	2681610001710130	2681610001710135	2681610001710140	2681610001710145	2681610001710150
	<b>6 + 10 + 3 micros</b>	2681610031710130	2681610031710135	2681610031710140	2681610031710145	2681610031710150
	<b>6 + 10 + 5* micros</b>	2681610XX1710130	2681610XX1710135	2681610XX1710140	2681610XX1710145	2681610XX1710150
	<b>6 + 10 + 7 micros</b>	2681610071710130	2681610071710135	2681610071710140	268161006151019080D/E	2681610071710150
	<b>6 Jatos água + 10 jatos ar</b>	2691610001710130	2691610001710135	2691610001710140	2691610001710145	2691610001710150
	<b>6 + 10 + 3 micros</b>	269161031710130	2691610031710135	2691610031710140	2691610031710145	2691610031710150
	<b>6 + 10 + 5* micros</b>	2691610XX1710130	2691610XX1710135	2691610XX1710140	2691610XX1710145	269161003151019080D/E
	<b>6 + 10 + 7 micros</b>	2691610071710130	2691610071710135	2691610071710140	2691610071710145	2691610071710150
Eletrónico Kombi ABS Kombi electronic ABS	<b>6 Jatos água + 10 jatos ar</b>	2631610001710130	2631610001710135	2631610001710140	2631610001710145	2631610001710150
	<b>6 + 10 + 3 micros</b>	2631610031710130	2631610031710135	2631610031710140	2631610031710145	2631610031710150
	<b>6 + 10 + 5* micros</b>	2631610XX1710130	2631610XX1710135	2631610XX1710140	2631610XX1710145	2631610XX1710150
	<b>6 + 10 + 7 micros</b>	2631610071710130	2631610071710135	2631610071710140	2631610071710145	2631610071710150
	<b>6 Jatos água + 10 jatos ar</b>	2631610001710130	2631610001710135	2631610001710140	2631610001710145	2631610001710150
	<b>6 + 10 + 3 micros</b>	2631610031710130	2631610031710135	2631610031710140	2631610031710145	2631610031710150
	<b>6 + 10 + 5* micros</b>	2631610XX1710130	2631610XX1710135	2631610XX1710140	2631610XX1710145	2631610XX1710150
	<b>6 + 10 + 7 micros</b>	2631610071710130	2631610071710135	2631610071710140	2631610071710145	2631610071710150

As banheiras equipadas com sistema de hidromassagem incluem no preço os pés de apoio e válvula de descarga automática - produto feito por encomenda. \* O conjunto de 5 micros pode ser combinado de 2 formas: 5 costas + 0 pés (5C) ou 3 costas + 2 pés (5P). Whirlpool bathtubs equipped with brass or ABS systems include Bathtub support feet and automatic discharge valve | Product make to order | \*\*The set of 5 microjets may be combined of two ways: 5 Back + 0 Feet (5C) or 3 Back + 2 Feet (5P).



»> CHARME →

Banheira Charme equipada com sistema de hidromassagem eletrónico Kombi em abs cromado, com opção 7 microjatos; Painel frontal madeira 1800x500 lacado vermelho rubi brilhante; Painel lateral madeira 800x500 lacado vermelho rubi brilhante.

Bathtub Charme equipped with Kombi electronic whirlpool system in chromed abs, optional 7 micro jets; Front panel, wood 1800x500 lacquered red ruby high gloss; Side panel, wood 800x500 lacquered red ruby high gloss.



Pés de apoio banheira  
Bathtub support feet



Almofada poliuretano preta  
Black headrest



Válvula descarga automática  
Automatic discharge valve

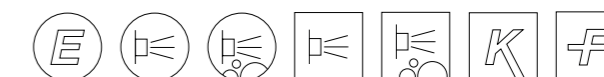







## »> CLÁSSICA DUO →

Banheira Clássica-Duo equipada com sistema de hidromassagem pneumático simples ABS cromado com opção 6 microjatos; Painel frontal acrílico branco 1900x500; Painel lateral direito acrílico branco 900x500.

Clássica-Duo Bathtub equipped with pneumatic simple whirlpool system in chromed ABS, optional 6 micro jets; Front acrylic panel in white 1900x500; Right side acrylic panel in white 900x500.

- 
Pés de apoio banheira  
Bathtub support feet
- 
Par pegas cromadas  
Chrome handles
- 
Válvula descarga automática  
Automatic discharge valve

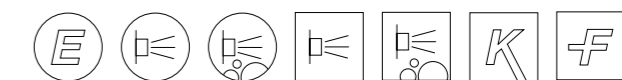



# CLÁSSICA DUO →

B ↓ A →

1900x900

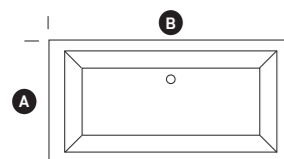

## Painéis em fenólico Phenolic panels



Castanho - Brown (10)



Faia - Beech (11)

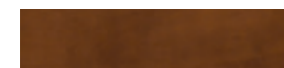

Mel - Honey (12)

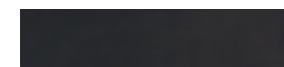

Wengué (13)

## Lacado brilho Lacquered



Verde - Green (22)



Laranja - Orange (23)



Violeta - Violet (24)



Rubi - Ruby (25)



Grafite - Graphit (26)



Preto - Black (27)



	1900x900
Banheira acrílica simples branca White acrylic bathtub	06010810190
Pés de apoio banheira Bathtub support feet	KT060104
Painel frontal acrílico branco White acrylic frontal panel	0811011019050
Painel lateral acrílico branco dir/esq - P.104 White acrylic lateral right/left panel - P104	081102109050D/E
Painel frontal fenólico Phenolic frontal panel	082001XX19050
Painel lateral fenólico Phenolic lateral panel	082002XX9050
Painel frontal madeira lacada Lacquered frontal wood panel	082001XX19050
Painel lateral madeira lacada Lacquered lateral wood panel	082002XX9050
Substituir XX pelo acabamento em Fenólico ou Madeira lacada - Replace XX with the finish in Phenolic or lacquered wood Produção por encomenda, prazo de entrega 4 semanas - Make to order, delivery 4 weeks	
Par pegas cromadas - Chrome handles	0701001
Válvula descarga automática cromada - Automatic discharge valve chrome	071001
Dados técnicos - Technical data - P101	

## Tabela de preços → Price-list

Sistema ABS - ABS system Banheira branca/ jatos cromados White bathtub/ chromed jets	1900x900
Ecoline Ecoline	6 Jatos água 26E16000810190D/E
	6 + 3 micros 26E16030810190D/E
	6 + 5* micros --
Ecoline Ecoline	6 + 6 micros 26E16060810190D/E
	6 Jatos água 26416000810190D/E
	6 + 3 micros 26416030810190D/E
Pneumático simples ABS Simple pneumatic ABS	6 + 5* micros --
	6 + 6 micros 26416060810190D/E
	6 Jatos água 26616000810190D/E
Eletrónico simples ABS Simple electronic ABS	6 + 3 micros 26616030810190D/E
	6 + 5* micros ---
	6 + 6 micros 26616060810190D/E
Pneumático duplo ABS Double pneumatic ABS	6 Jatos água + 10 jatos ar 2651610000810190D/E
	6 + 10 + 3 micros 2651610030810190D/E
	6 + 10 + 5* micros --
Eletrónico duplo ABS Double electronic ABS	6 + 10 + 6 micros 2651610060810190D/E
	6 Jatos água + 10 jatos ar 2681610000810190D/E
	6 + 10 + 3 micros 2681610030810190D/E
Eletrónico duplo ABS Double electronic ABS	6 + 10 + 5* micros ---
	6 + 10 + 6 micros 2681610060810190D/E
	6 Jatos água + 10 jatos ar 2691610000810190D/E
Eletrónico Kombi ABS Kombi electronic ABS	6 + 10 + 3 micros 2691610030810190D/E
	6 + 10 + 5* micros ---
	6 + 10 + 6 micros 2691610060810190D/E
Sistema em latão - Brass system Banheira branca/ jatos cromados White bathtub/ chromed jets	1900x900
Eletrónico duplo Flat latão Double electronic Flat brass	6 Jatos água + 10 jatos ar 2631610000810190D/E
	6 + 10 + 3 micros 2631610030810190D/E
	6 + 10 + 5* micros ---
Eletrónico duplo Flat latão Double electronic Flat brass	6 + 10 + 6 micros 2631610060810190D/E





As banheiras equipadas com sistema de hidromassagem incluem no preço os pés de apoio e válvula de descarga automática - produto feito por encomenda. \* O conjunto de 5 micros pode ser combinado de 2 formas: 5 costas + 0 pés (5C) ou 3 costas + 2 pés (5P).  
Whirlpool bathtubs equipped with brass or ABS systems include Bathtub support feet and automatic discharge valve | Product made to order | \*\*The set of 5 microjets may be combined of two ways: 5 Back + 0 Feet (5C) or 3 Back + 2 Feet (5P).



## »> CLÁSSICA →

Banheira Clássica equipada com sistema de hidromassagem eletrónico simples abs cromado, com opção 7 microjatos; Almofada em poliuretano integral skin preto; Painel frontal madeira 1700x500 faia; Painel lateral madeira 800x500 faia; Par de pegas cromadas.

Clássica Bath tub equipped with electronic simple whirlpool system in chromed abs, optional 7 micro jets; Headrest in black integral skin polyurethane; Front panel, beech wood 1700x500; Side panel, beech wood 800x500; Pair of chromed handles.

- 
Pés de apoio banheira  
Bath support feet
- 
Par pegas cromadas  
Chrome handles
- 
Almofada poliuretano preta  
Black headrest
- 
Válvula descarga automática  
Automatic discharge valve

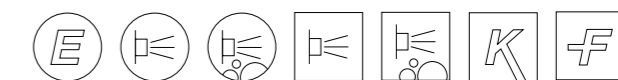

B ↓ A →

1200x700

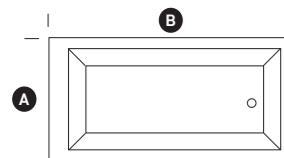

Painéis em fenólico  
Phenolic panels



Castanho - Brown (10)



Faia - Beech (11)

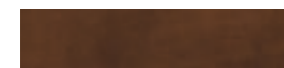

Mel - Honey (12)



Wengué (13)

Lacado brilho  
Lacquered



Verde - Green (22)



Laranja - Orange (23)



Violeta - Violet (24)



Rubi - Ruby (25)



Grafite - Graphit (26)



Preto - Black (27)



1200x700

Banheira acrílica simples branca White acrylic bathtub	.	0601161012070
Pés de apoio banheira Bathtub support feet	.	KT060102
Painel frontal acrílico branco White acrylic frontal panel	.	0811011012050
Painel lateral acrílico branco dir/esq - P.104 White acrylic lateral right/left panel - P104	.	081102107050D/E
Painel frontal fenólico Phenolic frontal panel	.	082001XX12050
Painel lateral fenólico Phenolic lateral panel	.	082002XX7050
Painel frontal madeira lacada Lacquered frontal wood panel	.	082001XX12050
Painel lateral madeira lacada Lacquered lateral wood panel	.	082002XX7050
Substituir XX pelo acabamento em Fenólico ou Madeira lacada - Replace XX with the finish in Phenolic or lacquered wood		
Produção por encomenda, prazo de entrega 4 semanas - Make to order, delivery 4 weeks		
Válvula descarga automática - Automatic discharge valve	.	071001

Dados técnicos - Technical data - P102

B ↓ A →

1350x700

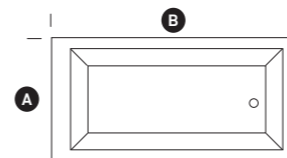

Painéis em fenólico  
Phenolic panels



Castanho - Brown (10)



Faia - Beech (11)

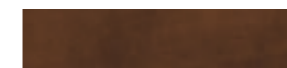

Mel - Honey (12)

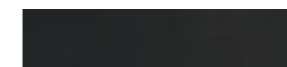

Wengué (13)

Lacado brilho  
Lacquered



Verde - Green (22)



Laranja - Orange (23)



Violeta - Violet (24)



Rubi - Ruby (25)



Grafite - Graphit (26)



Preto - Black (27)



1350x700

Banheira acrílica simples branca White acrylic bathtub	.	0601161013570
Pés de apoio banheira Bathtub support feet	.	KT060101
Painel frontal acrílico branco White acrylic frontal panel	.	0811011013550
Painel lateral acrílico branco dir/esq - P.104 White acrylic lateral panel right/left - P104	.	081102107050D/E
Painel frontal fenólico Phenolic frontal panel	.	082001XX13550
Painel lateral fenólico Phenolic lateral panel	.	082002XX7050
Painel frontal madeira lacada Lacquered frontal wood panel	.	082001XX13550
Painel lateral madeira lacada Lacquered lateral wood panel	.	082002XX7050
Substituir XX pelo acabamento em Fenólico ou Madeira lacada - Replace XX with the finish in Phenolic or lacquered wood		
Válvula descarga automática - Automatic discharge valve	.	071001

Dados técnicos - Technical data - P102

# CLÁSSICA →

B ↓ A →

1400x700

1500x700

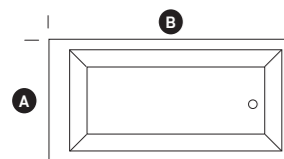

## Painéis em fenólico Phenolic panels



Castanho - Brown (10)



Faia - Beech (11)

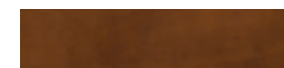

Mel - Honey (12)

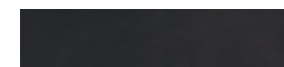

Wengué (13)

## Lacado brilho Lacquered



Verde - Green (22)



Laranja - Orange (23)



Violeta - Violet (24)



Rubi - Ruby (25)



Grafite - Graphit (26)



Preto - Black (27)

	1400x700	1500x700
Banheira acrílica simples branca White acrylic bathtub	0601161014070	0601161015070
Pés de apoio banheira Bathtub support feet	KT060101	KT060101
Painel frontal acrílico branco White acrylic frontal panel	0811011014050	0811011015050
Painel lateral acrílico branco dir/esq - P.104 White acrylic lateral right/left panel - P104	081102107050D/E	081102107050D/E
Painel frontal fenólico Phenolic frontal panel	082001XX14050	082001XX15050
Painel lateral fenólico Phenolic lateral panel	082002XX7050	082002XX7050
Painel frontal madeira lacada Lacquered frontal wood panel	082001XX14050	082001XX15050
Painel lateral madeira lacada Lacquered lateral wood panel	082002XX7050	082002XX7050
Substituir XX pelo acabamento em Fenólico ou Madeira lacada - Replace XX with the finish in Phenolic or lacquered wood Produção por encomenda, prazo de entrega 4 semanas - Make to order, delivery 4 weeks		
Par pegas cromadas - Chrome handles	0703010 (Dir./ 0703011 (Esq.)	.
Válvula descarga automática - Automatic discharge valve		071001

Dados técnicos - Technical data - P101

## Tabela de preços → Price-list

Sistema ABS - ABS system Banheira branca/ jatos cromados White bathtub/ chromed jets		1400x700	1500x700
	6 Jatos água	26E1600161014070D/E	26E1600161015070D/E
	6 + 3 micros	26E1603161014070D/E	26E1603161015070D/E
	6 + 5* micros	26E16XX161014070D/E	26E16XX161015070D/E
Ecoline Ecoline	6 + 7 micros	26E1607161014070D/E	26E1607161015070D/E
	6 Jatos água	2641600161014070D/E	2641600161015070D/E
	6 + 3 micros	2641603161014070D/E	2641603161015070D/E
	6 + *5 micros	26416XX161014070D/E	26416XX161015070D/E
	6 + 7 micros	2641607161014070D/E	2641607161015070D/E
	6 Jatos água	2661600161014070D/E	2661600161015070D/E
Ecoline Ecoline	6 + 3 micros	2661603161014070D/E	2661603161015070D/E
	6 + *5 micros	26616XX161014070D/E	26616XX161015070D/E
	6 + 7 micros	2661607161014070D/E	2661607161015070D/E
	6 Jatos água	2661600161014070D/E	2661600161015070D/E
	6 + 3 micros	2661603161014070D/E	2661603161015070D/E
	6 + *5 micros	26616XX161014070D/E	26616XX161015070D/E
Eletrónico simples ABS Simple electronic ABS	6 + 7 micros	2661607161014070D/E	2661607161015070D/E
	6 Jatos água + 10 jatos ar	--	--
	6 + 10 + 3 micros	--	--
	6 + 10 + 5* micros	--	--
	6 + 10 + 7 micros	--	--
	6 Jatos água + 10 jatos ar	--	--
Eletrónico duplo ABS Double electronic ABS	6 + 10 + 3 micros	--	--
	6 + 10 + 5* micros	--	--
	6 + 10 + 7 micros	--	--
	6 Jatos água + 10 jatos ar	269161000161014070D/E	269161000161015070D/E
	6 + 10 + 3 micros	269161003161014070D/E	269161003161015070D/E
	6 + 10 + 5* micros	2691610XX161014070D/E	2691610XX161015070D/E
Eletrónico Kombi ABS Kombi electronic ABS	6 + 10 + 7 micros	269161007161014070D/E	269161007161015070D/E
	Sistema em latão - Brass system Banheira branca/ jatos cromados White bathtub/ chromed jets		
		1400x700	1500x700
	6 Jatos água + 10 jatos ar	--	--
	6 + 10 + 3 micros	--	--
	6 + 10 + 5* micros	--	--
Eletrónico duplo Flat latão Double electronic Flat brass	6 + 10 + 7 micros	--	--

As banheiras equipadas com sistema de hidromassagem incluem no preço os pés de apoio e válvula de descarga automática - produto feito por encomenda. \* O conjunto de 5 micros pode ser combinado de 2 formas: 5 costas + 0 pés (5C) ou 3 costas + 2 pés (5P).  
Whirlpool bathtubs equipped with brass or ABS systems include Bathtub support feet and automatic discharge valve | Product make to order | \*\*The set of 5 microjets may be combined of two ways: 5 Back + 0 Feet (5C) or 3 Back + 2 Feet (5P).



## ⇒ PLANÍSSIMA → CANTO

Banheira Planíssima de Canto equipada com sistema de hidromassagem eletrónico Flat em latão cromado, com opção 7 microjatos; Almofadas em poliuretano integral skin preto; Conjunto torneira Nascente; Paineis frontal madeira 1800x500 lacado preto brilho; Painel lateral madeira 700x500 lacado preto brilho; Degrau parcial madeira lacado preto brilho; Bloco 2 gavetas madeira 550x700x500 lacadas preto brilho.

Planíssima Corner Bathtub equipped with Flat electronic whirlpool system in chromed brass, optional 7 micro jets; Headrests in black integral skin polyurethane; Nascente bath deck mixer; Front panel, wood 1800x500 special lacquered black; Side panel, wood 700x500 special lacquered black; Partial step, wood special lacquered black; Drawer unit, wood 550x700x500 special lacquered black with 2 drawers lacquered black high gloss.



Pés de apoio banheira  
Bathtub support feet



Almofada poliuretano preta  
Black headrest



Torneira de encastrar em banheira  
Bath deck mixer



Válvula descarga automática  
Automatic discharge valve

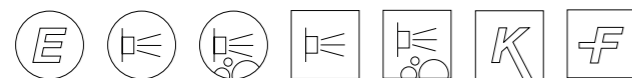

# PLANÍSSIMA → CANTO

B ↓ A → C →

1600x1000x650

1700x1000x650

1700x1200x650

1800x1300x700

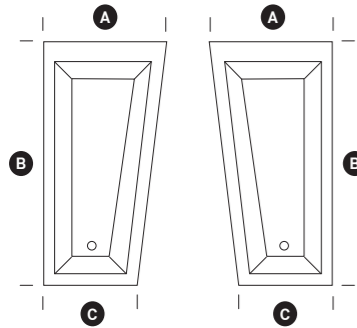

Painéis fenólico/ envernizado  
Phenolic panels/ varnished

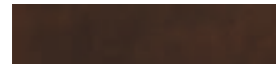

Castanho - Brown (10)



Faia - Beech (11)



Mel - Honey (12)



Wengué (13)

Lacado brilho  
Lacquered



Verde - Green (22)



Laranja - Orange (23)



Violeta - Violet (24)



Rubi - Ruby (25)



Grafite - Graphit (26)



Preto - Black (27)









Branco - White (20)



	1600x1000x650	1700x1000x650	1700x1200x650	1800x1300x700
Banheira acrílica simples branca White acrylic bathtub	06021510160100D/E	06021510170100D/E	06021510170120D/E	06021510180130D/E
Pés de apoio banheira Bathtub support feet	KT060109	KT060109	KT06010111	KT06010110
Painel frontal fenólico 1600/1700/1800 Phenolic frontal panel 1600/1700/1800	082201XX160100D/E	082201XX170100D/E	082201XX170120D/E	082201XX180130D/E
Painel lateral fenólico 650 /700 Phenolic lateral panel 650 /700	082202XX648D/E	082202XX653D/E	082202XX655D/E	082202XX700D/E
Painel lateral fenólico 1000 /1200/1300 Phenolic lateral panel 1000 /1200/1300	082203XX16100D/E	082203XX17100D/E	082203XX17120D/E	082203XX18130D/E
Painel frontal envernizado 1600/1700/1800 Varnished frontal panel 1600/1700/1800	082201XX160100D/E	082201XX170100D/E	082201XX170120D/E	082201XX180130D/E
Painel lateral envernizado 650 /700 Varnished lateral panel 650 /700	082202XX648D/E	082202XX653D/E	082202XX655D/E	082202XX700D/E
Painel lateral envernizado 1000 /1200/1300 Varnished lateral panel 1000 /1200/1300	082203XX16100D/E	082203XX17100D/E	082203XX17120D/E	082203XX18130D/E
Painel frontal lacado 1600/1700/1800 Lacquered frontal panel 1600/1700/1800	082203XX16100D/E	082203XX17100D/E	082203XX17120D/E	082203XX18130D/E
Painel lateral lacado 650 /700 Lacquered lateral panel 650 /700	082201XX1642D/E	082201XX653D/E	082201XX655 D/E	082201XX700D/E
Painel lateral lacado 1000 /1200/1300 Lacquered lateral panel 1000 /1200/1300	082203XX16100D/E	082203XX17100D/E	082203XX17120D/E	082203XX18130D/E
Substituir XX pelo acabamento em Fenólico ou Madeira lacada - Replace XX with the finish in Phenolic or lacquered wood Produção por encomenda, prazo de entrega 4 semanas - Make to order, delivery 4 weeks				
Almofada poliuretano preta - Black headrest				522304
Válvula descarga automática - Automatic discharge valve				071001
Montagem de torneira de cliente - Customer tap assembly			99MONTORNEIRA	
Torneira de encastrar em banheira - Bath deck mixer	<b>Consultar página - See page: 76 - 78</b>			
Dados técnicos - Technical data - P102				

## Tabela de preços → Price-list

Sistema ABS - ABS system Banheira branca/ jatos cromados White bathtub/ chromed jets	1600x1000x650	1700x1000x650	1700x1200x650	1800x1300x700
 <b>6 Jatos água</b>	26E16001510160100D/E	26E16001510170100D/E	26E16001510170120D/E	26E16001510180130D/E
<b>6 + 3 micros</b>	26E16031510160100D/E	26E16031510170100D/E	26E16031510170120D/E	26E16031510180130D/E
<b>6 + 5* micros</b>	26E16XX1510160100D/E	26E16XX1510170100D/E	26E16XX1510170120D/E	26E16XX1510180130D/E
<b>6 + 7 micros</b>	26E16071510160100D/E	26E16071510170100D/E	26E16071510170120D/E	26E16071510180130D/E
<b>6 Jatos água</b>	26416001510160100D/E	26416001510170100D/E	26416001510170120D/E	26416001510180130D/E
<b>6 + 3 micros</b>	26416031510160100D/E	26416031510170100D/E	26416031510170120D/E	26416031510180130D/E
<b>6 + 5* micros</b>	26416XX1510160100D/E	26416XX1510170100D/E	26416XX1510170120D/E	26416XX1510180130D/E
<b>6 + 7 micros</b>	26416071510160100D/E	26416071510170100D/E	26416071510170120D/E	26416071510180130D/E
 <b>6 Jatos água</b>	26616001510160100D/E	26616001510170100D/E	26616001510170120D/E	26616001510180130D/E
<b>6 + 3 micros</b>	26616031510160100D/E	26616031510170100D/E	26616031510170120D/E	26616031510180130D/E
<b>6 + 5* micros</b>	26616XX1510160100D/E	26616XX1510170100D/E	26616XX1510170120D/E	26616XX1510180130D/E
<b>6 + 7 micros</b>	26616071510160100D/E	26616071510170100D/E	26616071510170120D/E	26616071510180130D/E
 <b>6 Jatos água</b>	26616001510160100D/E	26616001510170100D/E	26616001510170120D/E	26616001510180130D/E
<b>6 + 3 micros</b>	26616031510160100D/E	26616031510170100D/E	26616031510170120D/E	26616031510180130D/E
<b>6 + 5* micros</b>	26616XX1510160100D/E	26616XX1510170100D/E	26616XX1510170120D/E	26616XX1510180130D/E
<b>6 + 7 micros</b>	26616071510160100D/E	26616071510170100D/E	26616071510170120D/E	26616071510180130D/E
 <b>6 Jatos água + 10 jatos ar</b>	26516100015101610D/E	26516100015101710D/E	26516100015101712D/E	26516100015101813D/E
<b>6 + 10 + 3 micros</b>	26516100315101610D/E	26516100315101710D/E	26516100315101712D/E	26516100315101813D/E
<b>6 + 10 + 5* micros</b>	2651610XX15101610D/E	2651610XX15101710D/E	2651610XX15101712D/E	2651610XX15101813D/E
<b>6 + 10 + 7 micros</b>	26516100715101610D/E	26516100715101710D/E	26516100715101712D/E	26516100715101813D/E
 <b>6 Jatos água + 10 jatos ar</b>	26816100015101610D/E	26816100015101710D/E	26816100015101712D/E	26816100015101813D/E
<b>6 + 10 + 3 micros</b>	26816100315101610D/E	26816100315101710D/E	26816100315101712D/E	26816100315101813D/E
<b>6 + 10 + 5* micros</b>	2681610XX15101610D/E	2681610XX15101710D/E	2681610XX15101712D/E	2681610XX15101813D/E
<b>6 + 10 + 7 micros</b>	26816100715101610D/E	26816100715101710D/E	26816100715101712D/E	26816100715101813D/E
 <b>6 Jatos água + 10 jatos ar</b>	26916100015101610D/E	26916100015101710D/E	26916100015101712D/E	26916100015101813D/E
<b>6 + 10 + 3 micros</b>	26916100315101610D/E	26916100315101710D/E	26916100315101712D/E	26916100315101813D/E
<b>6 + 10 + 5* micros</b>	2691610XX15101610D/E	2691610XX15101710D/E	2691610XX15101712D/E	2691610XX15101813D/E
<b>6 + 10 + 7 micros</b>	26916100715101610D/E	26916100715101710D/E	26916100715101712D/E	26916100715101813D/E
 <b>6 Jatos água + 10 jatos ar</b>	26316100015101610D/E	26316100015101710D/E	26316100015101712D/E	26316100015101813D/E
<b>6 + 10 + 3 micros</b>	26316100315101610D/E	26316100315101710D/E	26316100315101712D/E	26316100315101813D/E
<b>6 + 10 + 5* micros</b>	2631610XX15101610D/E	2631610XX15101710D/E	2631610XX15101712D/E	2631610XX15101813D/E
<b>6 + 10 + 7 micros</b>	26316100715101610D/E	26316100715101710D/E	26316100715101712D/E	26316100715101813D/E

As banheiras equipadas com sistema de hidromassagem incluem no preço os pés de apoio e válvula de descarga automática - produto feito por encomenda. \* O conjunto de 5 micros pode ser combinado de 2 formas: 5costas + 0 pés (5C) ou 3costas + 2pés (5P). Whirlpool bathtubs equipped with brass or ABS systems include Bathtub support feet and automatic discharge valve | Product make to order | \*\*The set of 5 microjets may be combined of two ways: 5 Back + 0 Feet (5C) or 3 Back + 2 Feet (5P).

## »» PLANÍSSIMA → CANTO COMPLEMENTOS

Degrau integral/ full step

Degrau parcial/ partial step

Módulo gavetas/ Drawer module

Complementos em madeira  
Wood complements  
Envernizado/ varnished



Castanho - Brown (10)



Faia - Beech (11)

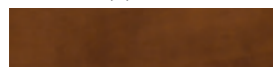

Mel - Honey (12)

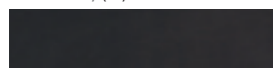

Wengué (13)

Lacado brilho  
Lacquered



Verde - Green (22)



Laranja - Orange (23)



Violeta - Violet (24)



Rubi - Ruby (25)



Grafite - Graphit (26)



Preto - Black (27)



Branco - White (20)



	1600x1000x650	1700x1000x650	1700x1200x650	1800x1300x700
Degrau integral envernizado Integral step varnished	0833 (00Dir) (01Esq) XX	0833 (00Dir) (01Esq) XX	0833 (00Dir) (01Esq) XX	0833 (00Dir) (01Esq) XX
Degrau parcial envernizado Partial step varnished	0832 (00Dir) (01Esq) XX	0832 (00Dir) (01Esq) XX	0832 (00Dir) (01Esq) XX	0832 (00Dir) (01Esq) XX
Módulo gavetas envernizado Drawer unit varnished	0850XX550650500	0850XX550650500	0850XX550650500	0850XX550650500
Degrau integral lacado Integral step lacquered	0833 (00Dir) (01Esq) XX	0833 (00Dir) (01Esq) XX	0833 (00Dir) (01Esq) XX	0833 (00Dir) (01Esq) XX
Degrau parcial lacado Partial step lacquered	0832 (00Dir) (01Esq) XX	0832 (00Dir) (01Esq) XX	0832 (00Dir) (01Esq) XX	0832 (00Dir) (01Esq) XX
Módulo gavetas lacado Drawer unit lacquered	0850XX550650500	0850XX550650500	0850XX550650500	0850XX550650500

Substituir XX pelo acabamento em Fenólico ou Madeira lacada - Replace XX with the finish in Phenolic or lacquered wood  
Produção por encomenda, prazo de entrega 4 semanas - Make to order, delivery 4 weeks











## »» PLANÍSSIMA DUO →

Banheira Planíssima Duo equipada com sistema eletrónico duplo ABS, com opção de 6 microjatos; Almofadas em poliuretano integral skin preto; Conjunto de torneira Nascente.

Planíssima Duo Bathtub equipped with electronic system, optional 6 micro jets; Headrests in black integral skin polyurethane; Nascente bath deck mixer.

- 
Pés de apoio banheira  
Bathtub support feet
- 
Almofada poliuretano preta  
Black headrest
- 
Torneira de encastrar em banheira  
Bath deck mixer
- 
Válvula descarga automática  
Automatic discharge valve

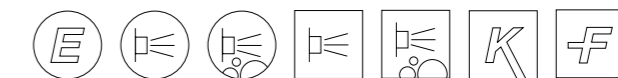

## → PLANÍSSIMA → DUO

B ↓ A →

1800x800

1800x900

1900x800

1900x900

2000x1000

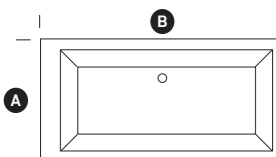

Painéis fenólico  
Phenolic panels



Castanho - Brown (10)



Faia - Beech (11)

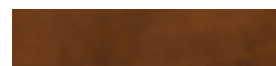

Mel - Honey (12)

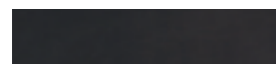

Wengué (13)

Lacado brilho  
Lacquered



Verde - Green (22)



Laranja - Orange (23)



Violeta - Violet (24)



Rubi - Ruby (25)



Grafite - Graphit (26)



Preto - Black (27)



	1800x800	1800x900	1900x800	1900x900	2000x1000
<b>Banheira acrílica simples branca</b> White acrylic bathtub	06011510118080	06011510180900	06011510190800	06011510190900	06011510200100
<b>Pés de apoio banheira</b> Bathtub support feet	KT060103	KT060104	KT060103	KT060104	KT060108
<b>Painel frontal acrílico branco</b> White acrylic frontal panel	0811011018050	0811011018050	0811011019050	0811011019050	0811011020050
<b>Painel lateral acrílico branco dir/esq - P.104</b> White acrylic lateral right/left panel - P104	081102108050D/E	081102109050D/E	081102108050D/E	081102109050D/E	0811021010050
<b>Painel frontal fenólico</b> Phenolic frontal panel	082001XX18050	082001XX18050	082001XX19050	082001XX19050	082001XX20050
<b>Painel lateral fenólico</b> Phenolic lateral panel	082002XX8050	082002XX9050	082002XX8050	082002XX9050	082002XX10050
<b>Painel frontal madeira lacada</b> Lacquered frontal wood panel	082001XX18050	082001XX18050	082001XX19050	082001XX19050	082001XX20050
<b>Painel lateral madeira lacado</b> Lacquered lateral wood panel	082002XX8050	082002XX9050	082002XX8050	082002XX9050	082002XX10050
Substituir XX pelo acabamento em Fenólico ou Madeira lacada - Replace XX with the finish in Phenolic or lacquered wood Produção por encomenda, prazo de entrega 4 semanas - Make to order, delivery 4 weeks					
<b>Almofada poliuretano preta - Black headrest</b>				522304	.
<b>Válvula descarga automática - Automatic discharge valve</b>				071001	.
<b>Montagem de torneira de cliente - Customer tap assembly</b>				99MONTORNEIRA	.
<b>Torneira de encastrar em banheira - Bath deck mixer</b>					<b>Consultar página - See page: 76 - 78</b>

Dados técnicos - Technical data - P103

## Tabela de preços → Price-list

Sistema ABS - ABS system  
Banheira branca/ jatos cromados  
White bathtub/ chromed jets

	1800x800	1800x900	1900x800	1900x900	2000x1000
<b>6 Jatos água</b>	26E16001510118080D/E	26E1600151018090D/E	26E1600151019080D/E	26E1600151019090D/E	26E16001510200100D/E
<b>6 + 3 micros</b>	26E16031510118080D/E	26E1603151018090D/E	26E1603151019080D/E	26E1603151019090D/E	26E16031510200100D/E
<b>6 + 5* micros</b>	--	--	--	--	--
<b>6 + 6 micros</b>	26E16061510118080D/E	26E1606151018090D/E	26E1606151019080D/E	26E1606151019090D/E	26E16061510200100D/E
<b>6 Jatos água</b>	26416001510118080D/E	2641600151018090D/E	2641600151019080D/E	2641600151019090D/E	26416001510200100D/E
<b>6 + 3 micros</b>	26416031510118080D/E	2641603151018090D/E	2641603151019080D/E	2641603151019090D/E	26416031510200100D/E
<b>6 + 5* micros</b>	--	--	--	--	--
<b>6 + 6 micros</b>	26416061510118080D/E	2641606151018090D/E	2641606151019080D/E	2641606151019090D/E	26416061510200100D/E
<b>6 Jatos água</b>	26616001510118080D/E	2661600151018090D/E	2661600151019080D/E	2661600151019090D/E	26616001510200100D/E
<b>6 + 3 micros</b>	26616031510118080D/E	2661603151018090D/E	2661603151019080D/E	2661603151019090D/E	26616031510200100D/E
<b>6 + 5* micros</b>	--	--	--	--	--
<b>6 + 6 micros</b>	26616061510118080D/E	2661606151018090D/E	2661606151019080D/E	2661606151019090D/E	26616061510200100D/E
<b>6 Jatos água + 10 jatos ar</b>	265161000151011880D/E	26516100015101890D/E	26516100015101980D/E	26516100015101990D/E	2651610001510200D/E
<b>6 + 10 + 3 micros</b>	265161003151011880D/E	26516100315101890D/E	26516100315101980D/E	26516100315101990D/E	2651610031510200D/E
<b>6 + 10 + 5* micros</b>	--	--	--	--	--
<b>6 + 10 + 6 micros</b>	265161006151011880D/E	26516100615101890D/E	26516100615101980D/E	26516100615101990D/E	2651610061510200D/E
<b>6 Jatos água + 10 jatos ar</b>	268161000151011880D/E	26816100015101890D/E	26816100015101980D/E	26816100015101990D/E	2681610001510200D/E
<b>6 + 10 + 3 micros</b>	268161003151011880D/E	26816100315101890D/E	26816100315101980D/E	26816100315101990D/E	2681610031510200D/E
<b>6 + 10 + 5* micros</b>	--	--	--	--	--
<b>6 + 10 + 6 micros</b>	268161006151011880D/E	26816100615101890D/E	26816100615101980D/E	26816100615101990D/E	2681610061510200D/E
<b>6 Jatos água + 10 jatos ar</b>	269161000151011880D/E	26916100015101890D/E	26916100015101980D/E	26916100015101990D/E	2691610001510200D/E
<b>6 + 10 + 3 micros</b>	269161003151011880D/E	26916100315101890D/E	26916100315101980D/E	26916100315101990D/E	2691610031510200D/E
<b>6 + 10 + 5* micros</b>	--	--	--	--	--
<b>6 + 10 + 6 micros</b>	269161006151011880D/E	26916100615101890D/E	26916100615101980D/E	26916100615101990D/E	2691610061510200D/E
<b>Sistema em latão - Brass system</b> Banheira branca/ jatos cromados White bathtub/ chromed jets					
<b>6 Jatos água + 10 jatos ar</b>	263161000151011880D/E	26316100015101890D/E	26316100015101980D/E	26316100015101990D/E	2631610001510200D/E
<b>6 + 10 + 3 micros</b>	263161003151011880D/E	26316100315101890D/E	26316100315101980D/E	26316100315101990D/E	2631610031510200D/E
<b>6 + 10 + 5* micros</b>	--	--	--	--	--
<b>6 + 10 + 6 micros</b>	263161006151011880D/E	26316100615101890D/E	26316100615101980D/E	26316100615101990D/E	2631610061510200D/E

As banheiras equipadas com sistema de hidromassagem incluem no preço os pés de apoio e válvula de descarga automática - produto feito por encomenda. \* O conjunto de 5 micros pode ser combinado de 2 formas: 5 costas + 0 pés (5C) ou 3 costas + 2 pés (5P).  
Whirlpool bathtubs equipped with brass or ABS systems include Bathtub support feet and automatic discharge valve | Product make to order | \*\*The set of 5 microjets may be combined of two ways: 5 Back + 0 Feet (5C) or 3 Back + 2 Feet (5P).

## ⇒ PLANÍSSIMA

Banheira Planíssima equipada com sistema de hidromassagem eletrônico duplo ABS cromado; Almofada em poliuretano integral skin preto; Painei frontal madeira 1800x500 wengué; Monocomando de banheira ao chão com chuveiro manual Quadra

Planíssima bathtub equipped with electronic double whirlpool system, chromed ABS; Headrest in black integral skin polyurethane; Front panel, wengué wood 1800x500; Quadra bath single-lever mixer floor mounting with waterfall spout, diverter and shower hand.

- 

**Pés de apoio banheira**  
 Bathtub support feet
- 

**Almofada poliuretano preta**  
 Black headrest
- 

**Torneira de encastrar em banheira**  
 Bath deck mixer
- 

**Válvula descarga automática**  
 Automatic discharge valve

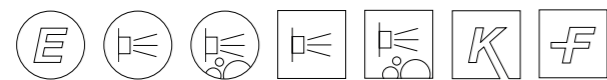

# PLANÍSSIMA

B ↓ A →

1500x700
1600x700
1600x750
1700x700
1700x750

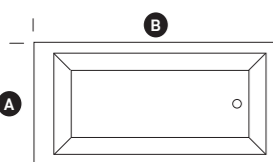

### Painéis fenólico Phenolic panels



Castanho - Brown (10)



Faia - Beech (11)

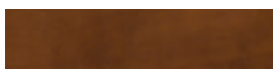

Mel - Honey (12)

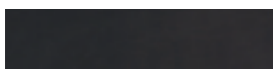

Wengué (13)

### Lacado brilho Lacquered



Verde - Green (22)



Laranja - Orange (23)



Violeta - Violet (24)



Rubi - Ruby (25)



Grafite - Graphit (26)



Preto - Black (27)



	1500x700	1600x700	1600x750	1700x700	1700x750
<b>Banheira acrílica simples branca</b> White acrylic bathtub	0601151015070	0601151016070	0601151016075	0601151017070	0601151017075
<b>Pés de apoio banheira</b> Bathtub support feet	KT060101	KT060101	KT060101	KT060101	KT060101
<b>Painel frontal acrílico branco</b> White acrylic frontal panel	0811011015050	0811011016050	0811011016050	0811011017050	0811011017050
<b>Painel lateral acrílico branco dir/esq - P.104</b> White acrylic lateral right/left panel - P104	081102107050D/E	081102107050D/E	081102107550D/E	081102107050D/E	081102107550D/E
<b>Painel frontal fenólico</b> Phenolic frontal panel	082001XX15050	082001XX16050	082001XX16050	082001XX17050	082001XX17050
<b>Painel lateral fenólico</b> Phenolic lateral panel	082002XX7050	082002XX7050	082002XX7550	082002XX7050	082002XX7550
<b>Painel frontal madeira lacada</b> Lacquered frontal wood panel	082001XX15050	082001XX16050	082001XX16050	082001XX17050	082001XX17050
<b>Painel lateral madeira lacada</b> Lacquered lateral wood panel	082002XX7050	082002XX7050	082002XX7550	082002XX7050	082002XX7550
Substituir XX pelo acabamento em Fenólico ou Madeira lacada - Replace XX with the finish in Phenolic or lacquered wood Produção por encomenda, prazo de entrega 4 semanas - Make to order, delivery 4 weeks					
<b>Almofada poliuretano preta - Black headrest</b>				522305	
<b>Válvula descarga automática - Automatic discharge valve</b>				071001	

Dados técnicos - Technical data - P103

## Tabela de preços → Price-list

Sistema ABS - ABS system Banheira branca/ jatos cromados White bathtub/ chromed jets		1500x700	1600x700	1600x750	1700x700	1700x750
	<b>6 Jatos água</b>	26E1600151015070D/E	26E1600151016070D/E	26E1600151016075D/E	26E1600151017070D/E	26E1600151017075D/E
	<b>6 + 3 micros</b>	26E1603151015070D/E	26E1603151016070D/E	26E1603151016075D/E	26E1603151017070D/E	26E1603151017075D/E
	<b>6 + 5* micros</b>	26E16XX151015070D/E	26E16XX151016070D/E	26E16XX151016075D/E	26E16XX151017070D/E	26E16XX151017075D/E
<b>Ecoline</b> Ecoline	<b>6 + 7 micros</b>	26E1607151015070D/E	26E1607151016070D/E	26E1607151016075D/E	26E1607151017070D/E	26E1607151017075D/E
	<b>6 Jatos água</b>	2641600151015070D/E	2641600151016070D/E	2641600151016075D/E	2641600151017070D/E	2641600151017075D/E
	<b>6 + 3 micros</b>	2641603151015070D/E	2641603151016070D/E	2641603151016075D/E	2641603151017070D/E	2641603151017075D/E
	<b>6 + 5* micros</b>	26416XX151015070D/E	26416XX151016070D/E	26416XX151016075D/E	26416XX151017070D/E	26416XX151017075D/E
<b>Pneumático simples ABS</b> Simple pneumatic ABS	<b>6 + 7 micros</b>	2641607151015070D/E	2641607151016070D/E	2641607151016075D/E	2641607151017070D/E	2641607151017075D/E
	<b>6 Jatos água</b>	2661600151015070D/E	2661600151016070D/E	2661600151016075D/E	2661600151017070D/E	2661600151017075D/E
	<b>6 + 3 micros</b>	661603151015070D/E	2661603151016070D/E	2661603151016075D/E	2661603151017070D/E	2661603151017075D/E
	<b>6 + 5* micros</b>	26616XX151015070D/E	26616XX151016070D/E	26616XX151016075D/E	26616XX151017070D/E	26616XX151017075D/E
<b>Elétrónico simples ABS</b> Simple electronic ABS	<b>6 + 7 micros</b>	2661607151015070D/E	2661607151016070D/E	2661607151016075D/E	2661607151017070D/E	2661607151017075D/E
	<b>6 Jatos água + 10 jatos ar</b>	26516100015101570D/E	26516100015101670D/E	26516100015101675D/E	26516100015101770D/E	26516100015101775D/E
	<b>6 + 10 + 3 micros</b>	26516100315101570D/E	26516100315101670D/E	26516100315101675D/E	26516100315101770D/E	26516100315101775D/E
	<b>6 + 10 + 5* micros</b>	2651610XX15101570D/E	2651610XX15101670D/E	2651610XX15101675D/E	2651610XX15101770D/E	2651610XX15101775D/E
<b>Pneumático duplo ABS</b> Double pneumatic ABS	<b>6 + 10 + 7 micros</b>	26516100715101570D/E	6516100715101670D/E	26516100715101675D/E	26516100715101770D/E	26516100715101775D/E
	<b>6 Jatos água + 10 jatos ar</b>	26816100015101570D/E	26816100015101670D/E	26816100015101675D/E	26816100015101770D/E	26816100015101775D/E
	<b>6 + 10 + 3 micros</b>	26816100315101570D/E	26816100315101670D/E	6816100315101675D/E	26816100315101770D/E	26816100315101775D/E
	<b>6 + 10 + 5* micros</b>	2681610XX15101570D/E	2681610XX15101670D/E	2681610XX15101675D/E	2681610XX15101770D/E	2681610XX15101775D/E
<b>Elétrónico duplo ABS</b> Double electronic ABS	<b>6 + 10 + 7 micros</b>	26816100715101570D/E	26816100715101670D/E	26816100715101675D/E	26816100715101770D/E	26816100715101775D/E
	<b>6 Jatos água + 10 jatos ar</b>	26916100015101570D/E	26916100015101670D/E	26916100015101675D/E	26916100015101770D/E	26916100015101775D/E
	<b>6 + 10 + 3 micros</b>	26916100315101570D/E	26916100315101670D/E	26916100315101675D/E	26916100315101770D/E	26916100315101775D/E
	<b>6 + 10 + 5* micros</b>	2691610XX15101570D/E	2691610XX15101670D/E	2691610XX15101675D/E	2691610XX15101770D/E	2691610XX15101775D/E
<b>Elétrónico Kombi ABS</b> Kombi electronic ABS	<b>6 + 10 + 7 micros</b>	26916100715101570D/E	26916100715101670D/E	26916100715101675D/E	26916100715101770D/E	26916100715101775D/E
<b>Sistema em latão - Brass system</b> Banheira branca/ jatos cromados White bathtub/ chromed jets		<b>1500x700</b>	<b>1600x700</b>	<b>1600x750</b>	<b>1700x700</b>	<b>1700x750</b>
	<b>6 Jatos água + 10 jatos ar</b>	26316100015101570D/E	26316100015101670D/E	26316100015101675D/E	26316100015101770D/E	26316100015101775D/E
	<b>6 + 10 + 3 micros</b>	26316100315101570D/E	26316100315101670D/E	6316100315101675D/E	26316100315101770D/E	26316100315101775D/E
	<b>6 + 10 + 5* micros</b>	2631610XX15101570D/E	2631610XX15101670D/E	2631610XX15101675D/E	2631610XX15101770D/E	2631610XX15101775D/E
<b>Elétrónico duplo Flat latão</b> Double electronic Flat brass	<b>6 + 10 + 7 micros</b>	26316100715101570D/E	26316100715101670D/E	26316100715101675D/E	26316100715101770D/E	26316100715101775D/E

As banheiras equipadas com sistema de hidromassagem incluem no preço os pés de apoio e válvula de descarga automática - produto feito por encomenda. \* O conjunto de 5 micros pode ser combinado de 2 formas: 5costas + 0 pés (5C) ou 3costas + 2pés (5P).  
Whirlpool bathtubs equipped with brass or ABS systems include Bathtub support feet and automatic discharge valve | Product made to order | \*\*The set of 5 microjets may be combined of two ways: 5 Back + 0 Feet (5C) or 3 Back + 2 Feet (5P).

# PLANÍSSIMA

B ↓ A →

1700x800

1800x750

1800x800

1900x900

1900x1000

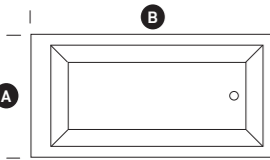

Painéis fenólico  
Phenolic panels



Castanho - Brown (10)



Faia - Beech (11)

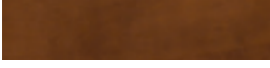

Mel - Honey (12)



Wengué (13)

Lacado brilho  
Lacquered



Verde - Green (22)



Laranja - Orange (23)



Violeta - Violet (24)



Rubi - Ruby (25)



Grafite - Graphit (26)



Preto - Black (27)

	1700x800	1800x750	1800x800	1900x900	1900x1000
<b>Banheira acrílica simples branca</b> White acrylic bathtub	0601151017080	0601151018075	0601151018080	06011510119090	060115101190100
<b>Pés de apoio banheira</b> Bathtub support feet	KT060103	KT060101	KT060103	KT060104	KT060108
<b>Painel frontal acrílico branco</b> White acrylic frontal panel	0811011017050	0811011018050	0811011018050	0811011019050	0811011019050
<b>Painel lateral acrílico branco dir/esq - P.104</b> White acrylic lateral right/left panel - P104	081102108050D/E	081102107550D/E	081102108050D/E	081102109050D/E	0811021010050
<b>Painel frontal fenólico</b> Phenolic frontal panel	082001XX17050	082001XX18050	082001XX18050	082001XX19050	082001XX19050
<b>Painel lateral fenólico</b> Phenolic lateral panel	082002XX8050	082002XX7550	082002XX8050	082002XX9050	082002XX10050
<b>Painel frontal madeira lacado</b> Lacquered frontal wood panel	082001XX17050	082001XX18050	082001XX18050	082001XX19050	082001XX19050
<b>Painel lateral madeira lacado</b> Lacquered lateral wood panel	082002XX8050	082002XX7550	082002XX8050	082002XX9050	082002XX10050
Substituir XX pelo acabamento em Fenólico ou Madeira lacada - Replace XX with the finish in Phenolic or lacquered wood Produção por encomenda, prazo de entrega 4 semanas - Make to order, delivery 4 weeks					
<b>Almofada poliuretano preta - Black headrest</b>				522305	.
<b>Válvula descarga automática - Automatic discharge valve</b>				071001	.
<b>Montagem de torneira de cliente - Customer tap assembly</b>				99MONTORNEIRA	.
<b>Torneira de encastrar em banheira - Bath deck mixer</b>					<b>Consultar página - See page: 76 - 78</b>

Dados técnicos - Technical data - P103

## Tabela de preços → Price-list

**Sistema ABS - ABS system**  
**Banheira branca/ jatos cromados**  
White bathtub/ chromed jets

	1700x800	1800x750	1800x800	1900x900	1900x1000
 <b>6 Jatos água</b>	26E1600151017080D/E	26E1600151018075D/E	26E1600151018080D/E	26E16001510119090D/E	26E160015101190100D/E
<b>6 + 3 micros</b>	26E1603151017080D/E	26E1603151018075D/E	26E1603151018080D/E	26E16031510119090D/E	26E160315101190100D/E
<b>6 + 5* micros</b>	26E16XX151017080D/E	26E16XX151018075D/E	26E16XX151018080D/E	26E16XX1510119090D/E	26E16XX15101190100D/E
<b>6 + 7 micros</b>	26E1607151017080D/E	26E1607151018075D/E	26E1607151018080D/E	26E16071510119090D/E	26E160715101190100D/E
<b>6 Jatos água</b>	2661600151017080D/E	2661600151018075D/E	2661600151018080D/E	26616001510119090D/E	266160015101190100D/E
<b>6 + 3 micros</b>	2661603151017080D/E	2661603151018075D/E	2661603151018080D/E	26616031510119090D/E	266160315101190100D/E
<b>6 + 5* micros</b>	26616XX151017080D/E	26616XX151018075D/E	26616XX151018080D/E	26616XX1510119090D/E	26616XX15101190100D/E
<b>6 + 7 micros</b>	2661607151017080D/E	2661607151018075D/E	2661607151018080D/E	26616071510119090D/E	266160715101190100D/E
<b>6 Jatos água + 10 jatos ar</b>	2661600151017080D/E	2661600151018075D/E	2661600151018080D/E	26616001510119090D/E	266160015101190100D/E
<b>6 + 3 micros</b>	2661603151017080D/E	2661603151018075D/E	2661603151018080D/E	26616031510119090D/E	266160315101190100D/E
<b>6 + 5* micros</b>	26616XX151017080D/E	26616XX151018075D/E	26616XX151018080D/E	26616XX1510119090D/E	26616XX15101190100D/E
<b>6 + 7 micros</b>	2661607151017080D/E	2661607151018075D/E	2661607151018080D/E	26616071510119090D/E	266160715101190100D/E
<b>6 Jatos água + 10 jatos ar</b>	26516100015101780D/E	26516100015101875D/E	26516100015101880D/E	26516100015101199D/E	26516100015101191D/E
<b>6 + 10 + 3 micros</b>	26516100315101780D/E	26516100315101875D/E	26516100315101880D/E	26516100315101199D/E	26516100315101191D/E
<b>6 + 10 + 5* micros</b>	2651610XX15101780D/E	2651610XX15101875D/E	2651610XX15101880D/E	2651610XX15101199D/E	2651610XX15101191D/E
<b>6 + 10 + 7 micros</b>	26516100715101780D/E	26516100715101875D/E	26516100715101880D/E	26516100715101199D/E	26516100715101191D/E
<b>6 Jatos água + 10 jatos ar</b>	26816100015101780D/E	26816100015101875D/E	26816100015101880D/E	26816100015101199D/E	26816100015101191D/E
<b>6 + 10 + 3 micros</b>	26816100315101780D/E	26816100315101875D/E	26816100315101880D/E	26816100315101199D/E	26816100315101191D/E
<b>6 + 10 + 5* micros</b>	2681610XX15101780D/E	2681610XX15101875D/E	2681610XX15101880D/E	2681610XX15101199D/E	2681610XX15101191D/E
<b>6 + 10 + 7 micros</b>	26816100715101775D/E	26816100715101875D/E	26816100715101880D/E	26816100715101199D/E	26816100715101191D/E
<b>6 Jatos água + 10 jatos ar</b>	26916100015101780D/E	26916100015101875D/E	26916100015101880D/E	26916100015101199D/E	26916100015101191D/E
<b>6 + 10 + 3 micros</b>	26916100315101780D/E	26916100315101875D/E	26916100315101880D/E	26916100315101199D/E	26916100315101191D/E
<b>6 + 10 + 5* micros</b>	2691610XX15101780D/E	2691610XX15101875D/E	2691610XX15101880D/E	2691610XX15101199D/E	2691610XX15101191D/E
<b>6 + 10 + 7 micros</b>	26916100715101780D/E	26916100715101875D/E	26916100715101880D/E	26916100715101199D/E	26916100715101191D/E
<b>Sistema em latão - Brass system</b> <b>Banheira branca/ jatos cromados</b> White bathtub/ chromed jets					
<b>6 Jatos água + 10 jatos ar</b>	26316100015101780D/E	26316100015101875D/E	26316100015101880D/E	26316100015101199D/E	26316100015101191D/E
<b>6 + 10 + 3 micros</b>	26316100315101780D/E	26316100315101875D/E	26316100315101880D/E	26316100315101199D/E	26316100315101191D/E
<b>6 + 10 + 5* micros</b>	2631610XX15101780D/E	2631610XX15101875D/E	2631610XX15101880D/E	2631610XX15101199D/E	2631610XX15101191D/E
<b>6 + 10 + 7 micros</b>	26316100715101780D/E	26316100715101875D/E	26316100715101880D/E	26316100715101199D/E	26316100715101191D/E

As banheiras equipadas com sistema de hidromassagem incluem no preço os pés de apoio e válvula de descarga automática - produto feito por encomenda. \* O conjunto de 5 micros pode ser combinado de 2 formas: 5 costas + 0 pés (5C) ou 3 costas + 2 pés (5P).  
Whirlpool bathtubs equipped with brass or ABS systems include Bathtub support feet and automatic discharge valve | Product made to order | \*\*The set of 5 microjets may be combined of two ways: 5 Back + 0 Feet (5C) or 3 Back + 2 Feet (5P).



## ELEGANCE → 1500x1500

Banheira Elegance equipada com sistema de hidromassagem electrónico duplo ABS cromado, com opção 6 microjactos. Painel acrílico branco com degrau 1500x550 (também disponível sem degrau).

Elegance bathtub equipped with electronic double whirlpool system in chromed ABS, 6 micro jets. White acrylic panel with step, 1500x550 (also available without step).



Pés de apoio banheira  
Bathtub support feet



Válvula descarga automática  
Automatic discharge valve

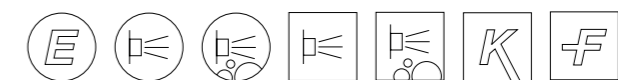







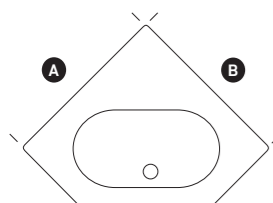

B ↓ A →

1500x1500



	1500x1500
Banheira acrílica simples branca White acrylic bathtub	06020710150
Pés de apoio banheira Bath tub support feet	KT060203
Painel de canto acrílico branco White acrylic corner panel	0801031015055
Painel canto acrílico branco com degrau White acrylic corner panel with step	0801041015055
Válvula descarga automática cromada Automatic discharge valve chrome	071001

Dados técnicos - Technical data - P104

Sistema ABS - ABS system Banheira branca/ jatos cromados White bathtub/ chromed jets		1500x1500
	6 Jatos água	26E16000710150D/E
	6 + 3 micros	26E16030710150D/E
	6 + 5* micros	--
	6 + 6 micros	26E16060710150D/E
Ecoline Ecoline		
	6 Jatos água	26416000710150D/E
	6 + 3 micros	26416030710150D/E
	6 + 5* micros	--
	6 + 6 micros	26416060710150D/E
Pneumático simples ABS Simple pneumatic ABS		
	6 Jatos água	26616000710150D/E
	6 + 3 micros	26616030710150D/E
	6 + 5* micros	---
	6 + 6 micros	26616060710150D/E
Eletrónico simples ABS Simple electronic ABS		
	6 Jatos água + 10 jatos ar	2651610000710150D/E
	6 + 10 + 3 micros	2651610030710150D/E
	6 + 10 + 5* micros	--
	6 + 10 + 6 micros	2651610060710150D/E
Pneumático duplo ABS Double pneumatic ABS		
	6 Jatos água + 10 jatos ar	2681610000710150D/E
	6 + 10 + 3 micros	2681610030710150D/E
	6 + 10 + 5* micros	---
	6 + 10 + 6 micros	2681610060710150D/E
Eletrónico duplo ABS Double electronic ABS		
	6 Jatos água + 10 jatos ar	2691610000710150D/E
	6 + 10 + 3 micros	2691610030710150D/E
	6 + 10 + 5* micros	---
	6 + 10 + 6 micros	2691610060710150D/E
Eletrónico Kombi ABS Kombi electronic ABS		
Sistema em latão - Brass system Banheira branca/ jatos cromados White bathtub/ chromed jets		1500x1500
	6 Jatos água + 10 jatos ar	2631610000710150D/E
	6 + 10 + 3 micros	2631610030710150D/E
	6 + 10 + 5* micros	---
	6 + 10 + 6 micros	2631610060710150D/E
Eletrónico duplo Flat latão Double electronic Flat brass		

As banheiras equipadas com sistema de hidromassagem incluem no preço os pés de apoio e válvula de descarga automática - produto feito por encomenda. \* O conjunto de 5 micros pode ser combinado de 2 formas: 5 costas + 0 pés (5C) ou 3 costas + 2 pés (5P). Whirlpool bathtubs equipped with brass or ABS systems include Bath tub support feet and automatic discharge valve | Product made to order | \*\*The set of 5 microjets may be combined of two ways: 5 Back + 0 Feet (5C) or 3 Back + 2 Feet (5P).



## TÍLIA → 1450X1450

Banheira Tília equipada com sistema hidromassagem electrónico duplo ABS cromado. Como opção os jactos de água foram substituídos por 24 microjactos. Paineil acrílico branco 1450x550 (também disponível com degrau).

Tília bathtub equipped with electronic double whirlpool system chromed ABS. Optionally, the water jets were replaced by 24 micro jets. White acrylic panel, 1450x550 (also available with step).

 Pés de apoio banheira  
Bathtub support feet

 Válvula descarga automática  
Automatic discharge valve

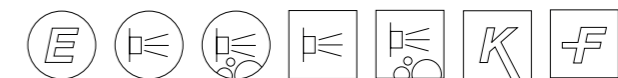



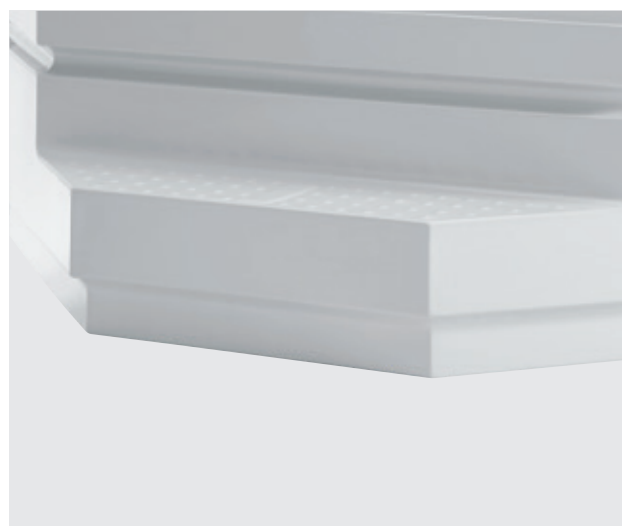

B ↓ A →

1450x1450

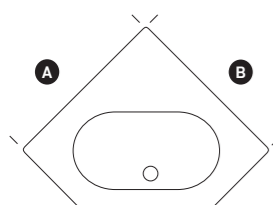

1450x1450		
Banheira acrílica simples branca White acrylic bathtub	.	06021210145
Pés de apoio banheira Bath tub support feet	.	KT060202
Painel de canto acrílico branco White acrylic corner panel	.	0801031014555
Painel canto acrílico branco com degrau White acrylic corner panel with step	.	0801041014555
Válvula descarga automática cromada Automatic discharge valve chrome	.	071001

Dados técnicos - Technical data - P105

Sistema ABS - ABS system Banheira branca/ jatos cromados White bathtub/ chromed jets		1450x1450
	6 Jatos água	26E16001210145D/E
	6 + 3 micros	26E16031210145D/E
	6 + 5* micros	--
Ecoline	6 + 6 micros	26E16061210145D/E
	6 Jatos água	26416001210145D/E
	6 + 3 micros	26416031210145D/E
	6 + 5* micros	--
Pneumático simples ABS Simple pneumatic ABS	6 + 6 micros	26416061210145D/E
	6 Jatos água	26616001210145D/E
	6 + 3 micros	26616031210145D/E
	6 + 5* micros	---
Eletrônico simples ABS Simple electronic ABS	6 + 6 micros	26616061210145D/E
	6 Jatos água + 10 jatos ar	2651610001210145D/E
	6 + 10 + 3 micros	2651610031210145D/E
	6 + 10 + 5* micros	--
Pneumático duplo ABS Double pneumatic ABS	6 + 10 + 6 micros	2651610061210145D/E
	6 Jatos água + 10 jatos ar	2681610001210145D/E
	6 + 10 + 3 micros	2681610031210145D/E
	6 + 10 + 5* micros	---
Eletrônico duplo ABS Double electronic ABS	6 + 10 + 6 micros	2681610061210145D/E
	6 Jatos água + 10 jatos ar	2691610001210145D/E
	6 + 10 + 3 micros	2691610031210145D/E
	6 + 10 + 5* micros	---
Eletrônico Kombi ABS	6 + 10 + 6 micros	2691610061210145D/E
	6 Jatos água + 10 jatos ar	2631610001210145D/E
	6 + 10 + 3 micros	2631610031210145D/E
	6 + 10 + 5* micros	---
Eletrônico duplo Flat latão	6 + 10 + 6 micros	2631610061210145D/E

As banheiras equipadas com sistema de hidromassagem incluem no preço os pés de apoio e válvula de descarga automática - produto feito por encomenda. \* O conjunto de 5 micros pode ser combinado de 2 formas: 5 costas + 0 pés (5C) ou 3 costas + 2 pés (5P). Whirlpool bathtubs equipped with brass or ABS systems include Bath tub support feet and automatic discharge valve | Product make to order | \*\*The set of 5 microjets may be combined of two ways: 5 Back + 0 Feet (5C) or 3 Back + 2 Feet (5P).

⇒ TULIPA ⇒

Banheira Tulipa equipada com sistema de hidromassagem electrónico duplo ABS, cromado com opção 6 microjactos e sistema de desinfeção automática. Painel acrílico branco 1400x550.

Tulipa bathtub equipped with electronic double whirlpool system in chromed ABS, 6 micro jets and automatic disinfection system optional. White acrylic panel 1400x550.



Pés de apoio banheira  
Bathtub support feet



Válvula descarga automática  
Automatic discharge valve

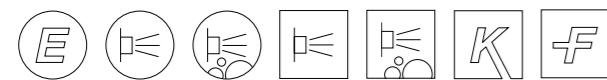



B ↓ A →

1400x1400

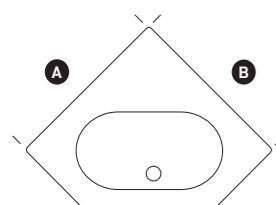

	1400x1400
Banheira acrílica simples branca White acrylic bathtub	06020510140
Pés de apoio banheira Bathtub support feet	KT060202
Painel de canto acrílico branco White acrylic corner panel	0801031014055
Válvula descarga automática cromada Automatic discharge valve chrome	071001

Dados técnicos - Technical data - P105

Sistema ABS - ABS system Banheira branca/ jatos cromados White bathtub/ chromed jets		1400x1400
	6 Jatos água	26E16000510140D/E
	6 + 3 micros	26E16030510140D/E
	6 + 5* micros	--
Ecoline Ecoline	6 + 6 micros	26E16060510140D/E
	6 Jatos água	26416000510140D/E
	6 + 3 micros	26416030510140D/E
	6 + 5* micros	--
	6 + 6 micros	26416060510140D/E
Pneumático simples ABS Simple pneumatic ABS	6 Jatos água	26616000510140D/E
	6 + 3 micros	26616030510140D/E
	6 + 5* micros	---
	6 + 6 micros	26616060510140D/E
	6 Jatos água	265160000510140D/E
	6 + 10 + 3 micros	2651610030510140D/E
Pneumático duplo ABS Double pneumatic ABS	6 + 10 + 5* micros	--
	6 + 10 + 6 micros	2651610060510140D/E
	6 Jatos água + 10 jatos ar	2681610000510140D/E
	6 + 10 + 3 micros	2681610030510140D/E
	6 + 10 + 5* micros	---
	6 + 10 + 6 micros	2681610060510140D/E
Eletrónico duplo ABS Double electronic ABS	6 Jatos água + 10 jatos ar	2691610000510140D/E
	6 + 10 + 3 micros	2651610030510140D/E
	6 + 10 + 5* micros	---
	6 + 10 + 6 micros	2691610060510140D/E
	6 Jatos água + 10 jatos ar	2631610000510140D/E
	6 + 10 + 3 micros	2631610030510140D/E
Eletrónico Kombi ABS Kombi electronic ABS	6 + 10 + 5* micros	---
	6 + 10 + 6 micros	2691610060510140D/E
	6 Jatos água + 10 jatos ar	2631610000510140D/E
	6 + 10 + 3 micros	2631610030510140D/E
	6 + 10 + 5* micros	---
	6 + 10 + 6 micros	2631610060510140D/E

As banheiras equipadas com sistema de hidromassagem incluem no preço os pés de apoio e válvula de descarga automática - produto feito por encomenda. \* O conjunto de 5 micros pode ser combinado de 2 formas: 5 costas + 0 pés (5C) ou 3 costas + 2 pés (5P). Whirlpool bathtubs equipped with brass or ABS systems include Bathtub support feet and automatic discharge valve | Product made to order | \*\*The set of 5 microjets may be combined of two ways: 5 Back + 0 Feet (5C) or 3 Back + 2 Feet (5P).



## GARDÉNIA → 1200x1200

Banheira Gardénia de Canto equipada com sistema de hidromassagem eletrônico simples ABS, com opção 7 microjatos; Monocomando banheira Quadra com bica, inversor, chuveiro de mão, suporte e flexível; Painel acrílico branco 1200x500.

Gardénia Corner bathtub equipped with electronic simple whirlpool system in chromed ABS, optional 7 micro jets; Bath mixer with spout, diverter, handshower, flexible and support; White acrylic panel 1200x500.



Pés de apoio banheira  
Bathtub support feet



Válvula descarga automática  
Automatic discharge valve





B ↓ A →

1200x1200

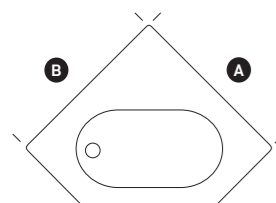

		1200x1200
Banheira acrílica simples branca	White acrylic bathtub	06021410120
Pés de apoio banheira	Bathtub support feet	KT060205
Painel de canto acrílico branco	White acrylic corner panel	0801031012050
Válvula descarga automática cromada	Automatic discharge valve chrome	071001

Dados técnicos - Technical data - P105

		1200x1200
Sistema ABS - ABS system Banheira branca/ jatos cromados White bathtub/ chromed jets		
	6 Jatos água	26E16001410120
	6 + 3 micros	26E16031410120
	6 + 5* micros	26E16XX1410120
Ecoline Ecoline	6 + 7 micros	26E16071410120
	6 Jatos água	26416001410120
	6 + 3 micros	26416031410120
	6 + 5* micros	26416XX1410120
Pneumático simples ABS Simple pneumatic ABS	6 + 7 micros	26416071410120
	6 Jatos água	26616001410120
	6 + 3 micros	26616031410120
	6 + 5* micros	26616XX1410120
Eletrônico simples ABS Simple electronic ABS	6 + 7 micros	26616071410120



As banheiras equipadas com sistema de hidromassagem incluem no preço os pés de apoio e válvula de descarga automática - produto feito por encomenda. \* O conjunto de 5 micros pode ser combinado de 2 formas: 5 costas + 0 pés (5C) ou 3 costas + 2 pés (5P).  
Whirlpool bathtubs equipped with brass or ABS systems include Bathtub support feet and automatic discharge valve | Product make to order | \*\*The set of 5 microjets may be combined of two ways: 5 Back + 0 Feet (5C) or 3 Back + 2 Feet (5P).



## CAMÉLIA → 1580x1030

Banheira Camélia esquerda equipada com sistema de hidromassagem pneumático duplo ABS cromado, com opção 7 microjatos. Painel acrílico branco esquerdo 1580x500.

Camélia left bathtub equipped with pneumatic double whirlpool system in chromed ABS, optional 7 micro jets. Left white acrylic panel 1580x500.

- 
Pés de apoio banheira  
Bathtub support feet
- 
Válvula descarga automática  
Automatic discharge valve

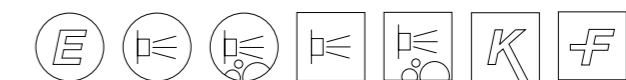

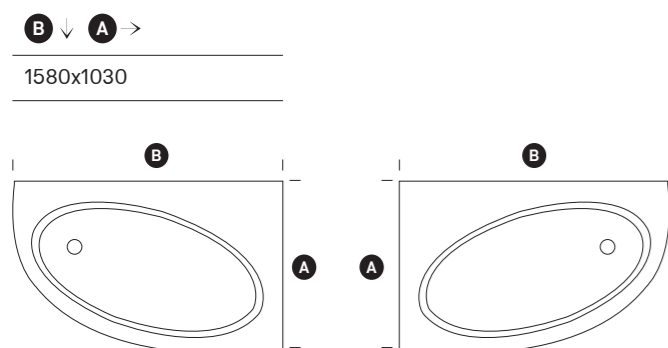

1580x1030	
Banheira acrílica simples branca White acrylic bathtub	060210D10158 (direita) / 060210E10158 (esquerda)
Pés de apoio banheira Bathtub support feet	KT060204
Painel de canto acrílico branco White acrylic corner panel	0801031015850D/E
Válvula descarga automática cromada Automatic discharge valve chrome	071001

Dados técnicos - Technical data - P105

Sistema ABS - ABS system Banheira branca/ jatos cromados White bathtub/ chromed jets		1580x1030
	6 Jatos água	26E160010D/E10158
	6 + 3 micros	26E160310D/E10158
	6 + 5* micros	26E16XX10D/E10158
	6 + 7 micros	26E160710D/E10158
Ecoline Ecoline	6 Jatos água	264160010D/E10158
	6 + 3 micros	264160310D/E10158
	6 + 5* micros	26416XX10D/E10158
	6 + 7 micros	264160710D/E10158
	6 Jatos água	264160010D/E10158
	6 + 3 micros	264160310D/E10158
	6 + 5* micros	26416XX10D/E10158
	6 + 7 micros	264160710D/E10158
Pneumático simples ABS Simple pneumatic ABS	6 Jatos água	266160010D/E10158
	6 + 3 micros	266160310D/E10158
	6 + 5* micros	26616XX10D/E10158
	6 + 7 micros	266160710D/E10158
	6 Jatos água	266160010D/E10158
	6 + 3 micros	266160310D/E10158
	6 + 5* micros	26616XX10D/E10158
	6 + 7 micros	266160710D/E10158
Eletrónico simples ABS Simple electronic ABS	6 Jatos água + 10 jatos ar	26516100010D/E10158
	6 + 10 + 3 micros	26516100310D/E10158
	6 + 10 + 5* micros	2651610XX10D/E10158
	6 + 10 + 7 micros	26516100710D/E10158
	6 Jatos água + 10 jatos ar	26816100010D/E10158
	6 + 10 + 3 micros	26816100310D/E10158
	6 + 10 + 5* micros	2681610XX10D/E10158
	6 + 10 + 7 micros	26816100710D/E10158
Eletrónico duplo ABS Double pneumatic ABS	6 Jatos água + 10 jatos ar	26916100010D/E10158
	6 + 10 + 3 micros	26916100310D/E10158
	6 + 10 + 5* micros	2691610XX10D/E10158
	6 + 10 + 7 micros	26916100710D/E10158
	6 Jatos água + 10 jatos ar	26916100010D/E10158
	6 + 10 + 3 micros	26916100310D/E10158
	6 + 10 + 5* micros	2691610XX10D/E10158
	6 + 10 + 7 micros	26916100710D/E10158
Eletrónico duplo ABS Double electronic ABS	6 Jatos água + 10 jatos ar	26916100010D/E10158
	6 + 10 + 3 micros	26916100310D/E10158
	6 + 10 + 5* micros	2691610XX10D/E10158
	6 + 10 + 7 micros	26916100710D/E10158
Sistema em latão - Brass system Banheira branca/ jatos cromados White bathtub/ chromed jets	6 Jatos água + 10 jatos ar	26316100010D/E10158
	6 + 10 + 3 micros	26316100310D/E10158
	6 + 10 + 5* micros	2631610XX10D/E10158
	6 + 10 + 7 micros	26316100710D/E10158
	6 Jatos água + 10 jatos ar	26316100010D/E10158
	6 + 10 + 3 micros	26316100310D/E10158
	6 + 10 + 5* micros	2631610XX10D/E10158
	6 + 10 + 7 micros	26316100710D/E10158

As banheiras equipadas com sistema de hidromassagem incluem no preço os pés de apoio e válvula de descarga automática - produto feito por encomenda. \* O conjunto de 5 micros pode ser combinado de 2 formas: 5 costas + 0 pés (5C) ou 3 costas + 2 pés (5P). Whirlpool bathtubs equipped with brass or ABS systems include Bathtub support feet and automatic discharge valve | Product made to order | \*\*The set of 5 microjets may be combined of two ways: 5 Back + 0 Feet (5C) or 3 Back + 2 Feet (5P).

Hidromassagem

*Whirlpool*

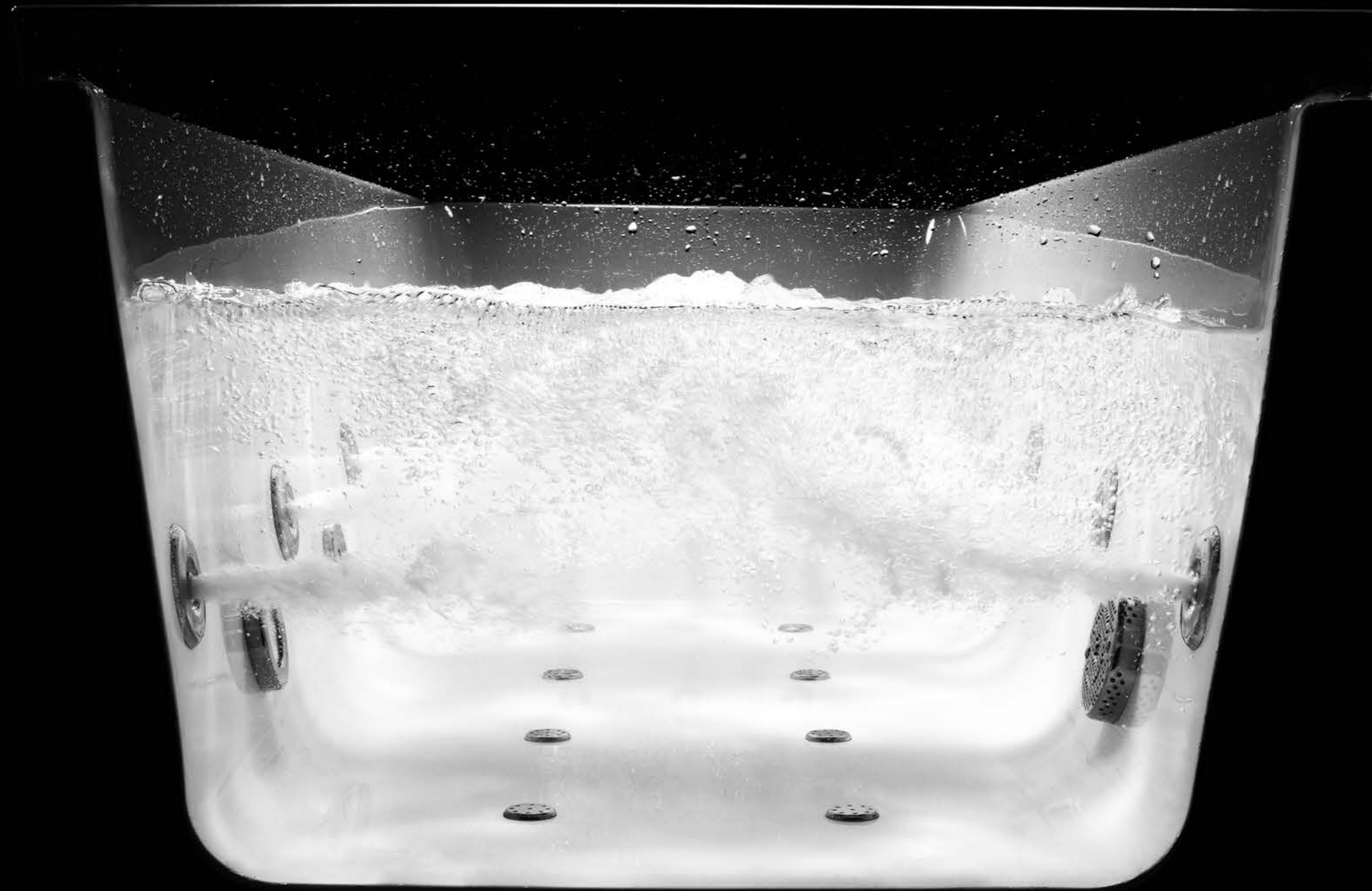



# HIDROMASSAGEM WHIRLPOOL →

## Jatos de água laterais

Lateral water jets

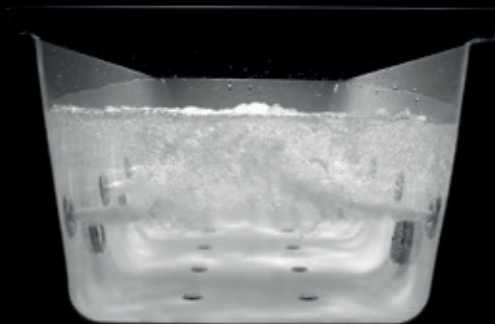

### Segurança

Conforme as normas CE, a proteção elétrica é feita por intermédio de um dispositivo de corrente residual (ddr) tendo uma corrente nominal não excedendo os 30mA, a sua instalação deve ficar no quadro geral da habitação, com uma linha direta à banheira de hidromassagem.

### Safety

According to the CE norms, the electric protection is made through a residual current operator circuit breaker (rccb) device where the nominal current doesn't exceed the 30mA, the installation should be made in the electric panel boarder of the house, with a direct line to the whirlpool.

## Jatos de ar inferiores

Bottom air jets

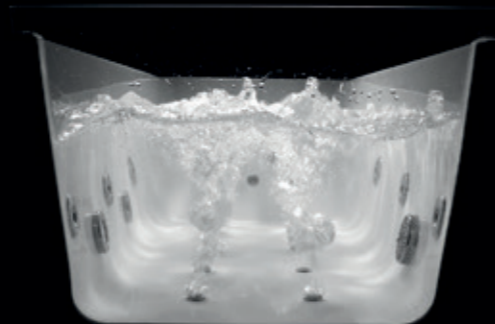

### Garantia

As banheiras ASD são testadas rigorosamente garantindo a sua perfeita segurança elétrica e o seu bom funcionamento. Os equipamentos de hidromassagem ASD têm uma garantia de 3 anos e dispõem de serviço de assistência técnica em todo o país. Serviço de apoio ao cliente ASD: 808 208 088

### Warranty

The ASD whirlpool are tested guaranteeing their strictly perfect electric safety and it's well function. The whirlpool equipments ASD have 3 years warranty and technical support service in all country. ASD customer service: 808 208 088

### Sistema De Desinfecção

Desinfection System



### Lâmpada de iodo

Spa light



### Microjatos

Microjets



### Jatos de pescoço

Neck jets



### Cromoterapia

A cromoterapia é um tratamento terapêutico alternativo ou complementar que usa a natureza da cor e da sua vibração para estabelecer o equilíbrio biológico e a harmonia das faculdades mentais e dos estados emocionais, restaurando o equilíbrio físico-energético em áreas do corpo humano atingidas por alguma disfunção. A cromoterapia usa as cores do espectro solar (branco, vermelho, amarelo, verde, ciano, violeta e azul).

### Chromotherapy

Chromotherapy is an alternative or complementary treatment, based on the nature and vibration of colour, it is used to establish biological balance, emotional states and mental harmony, restoring physical and energetic balance in certain areas of the human body which have been affected by some kind of dysfunction. Chromotherapy uses the colours of the solar spectrum, which are known to be: white, red, yellow, green, indigo, violet and blue.

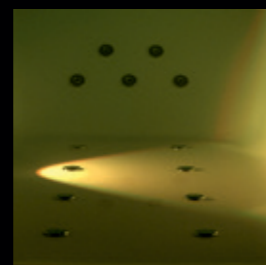

Amarelo - Yellow



Branco - White



Verde - Green



Ciano - Indigo



Azul - Blue



Violeta - Violet

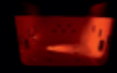

Vermelho - Red

## Tabela de preços → Price-list

### ILUMINAÇÃO

LIGHT

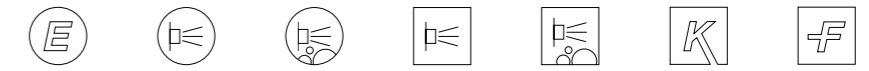

Lâmpada de iodo* Spa light	2606LAMPADA	--	--	--	--	.	.	.
Cromoterapia* (Comando adicional) Chromotherapy* (Additional command)	2606CROMOTERAPIA	--	--	--	.	.	.	.

\*Não poderão ser aplicadas em simultâneo - They can not be applied simultaneously

### OUTROS ACESSÓRIOS

OTHER ACCESSORIES

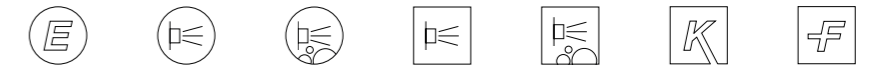

Desinfecção automática Automatic disinfection	2606DESINFECCAO	--	--	--	--	.	--	.
Aromaterapia Aromatherapy	2606AROMOTERAPIA	--	.	.	.	.	.	.
Disjuntor diferencial 30mA Rccb 30mA	524010	.	incluído included in	incluído included in	incluído included in	incluído included in	incluído included in	incluído included in
Sensor nível água Water level sensor	56011601	.	incluído included in	incluído included in	incluído included in	incluído included in	incluído included in	incluído included in

Jatos de pescoço - 2 unidades Neck jets - 2 units	2606NECKJET	.	.	.	.	.	.	.
--	-------------	---	---	---	---	---	---	---

Comando à distância Remote control	2606COMDIST	--	--	--	--	.	--	.
---------------------------------------	-------------	----	----	----	----	---	----	---

Válvula de enchimento e descarga automática com dreno Bath pop-up waste with overflow water outlet spout with drain	56260021	--	--	.	--	.	.	.
--	----------	----	----	---	----	---	---	---

Válvula de enchimento com descarga automática Bath pop-up waste with overflow water outlet spout	56260020	--	.	--	.	--	--	--
---	----------	----	---	----	---	----	----	----

### JATOS SUPLEMENTARES

ADDITIONAL JETS

### CROMADO

CHROMED

Jatos de água laterais abs/latão (unidade) Lateral water jets abs/brass (unit)		.	.	.	.	.	.	.
---	--	---	---	---	---	---	---	---

Microjatos abs/latão (unidade) para zonas lombar, dorsal e pés Micro jets abs/brass (unit) to lumbar, dorsal and feet areas		.	.	.	.	.	.	.
--	--	---	---	---	---	---	---	---

Jatos de ar inferiores abs/latão - 2 unidades (apenas disponível para sistema de hidromassagem duplo) Inferior air jets abs/brass - 2 units (only available for double whirlpool system)		.	.	.	.	.	.	.
---	--	---	---	---	---	---	---	---

Líquido de limpeza para sistema de desinfecção (1L) Cleaner liquid for disinfection system (1L)	2606CHEMENE	.	.	.	.	.	.	.
--	-------------	---	---	---	---	---	---	---

Kit de reparação para banheiras e bases de duche acrílicas Repair kit for acrylic bathtubs and shower trays	0704001	.	.	.	.	.	.	.
--	---------	---	---	---	---	---	---	---

Cadeia de 12 leds (7 cores) para banheiras 1700x700 a 2000x1000. Para instalação em banheiras simples ou de hidromassagem; Terapia de luz que alterna suavemente entre 7 cores; Tecnologia totalmente segura. leds impermeáveis.

12 Leds chain (7 colors) for bathtubs 1700x700 to 2000x1000. For the installation in bathtubs or whirlpools; Color-light therapy with 7 gently alternating colors; Totally safe technology - leds waterproof.

### 2606LED



Ecoline  
Ecoline



6 injetores de água laterais orientáveis em ABS; Comando pneumático de 2 funções: on/off, massagem de água e regulação manual de caudal (mistura de ar); Crivo de sucção ABS; Motor 650w IP54 230-240-V 3A; Válvula de descarga automática; Ligação equipotencial; 2 anos de garantia contra defeitos de fabrico. Disponível em cromado.

6 lateral swivelling water jets in ABS; Pneumatic press button control 2 functions: on/off water massage and manual air control; Suction strainer in ABS; 650w IP54 230-240-V 3A jet pump; Automatic discharge valve; Equipotential connection; 2 years guarantee against manufacture defects. Available in chromed.



Pneumático simples ABS  
Simple pneumatic ABS



6 injetores de água laterais orientáveis em ABS; Comando pneumático de 2 funções: on/off, massagem de água e regulação manual de caudal (mistura de ar); Crivo de sucção ABS; Motor 650w IP54 230-240-V 3A; Válvula de descarga automática; Quadro controlo pneumático com sensor nível de água; Ligação equipotencial; Interruptor diferencial monofásico proteção 25A/30mA - 240V - 50Hz; 2 anos de garantia contra defeitos de fabrico. Disponível em cromado.

6 lateral swivelling water jets in ABS; Pneumatic press button control, 2 functions: on/off water massage and manual air control; Suction strainer in ABS; 650w IP54 230-240-V 3A jet pump; Automatic discharge valve; Pneumatic control panel with water level sensor; Equipotential connection; Residual current operator circuit breaker (RCCB) 25A/30mA - 240V - 50Hz; 2 years guarantee against manufacture defects. Available in chromed.



Eletrónico simples ABS  
Simple electronic ABS



6 injetores de água laterais orientáveis em ABS; Comando digital de 3 funções: on/off massagem de água, intermitência automática de água e regulação manual de caudal (mistura de ar); Crivo de sucção ABS; Motor 650w IP54 230-240-V 3A / 800W IP54 230-240-V 3A (com micros); Válvula de descarga automática; Quadro controlo eletrónico KOLLER SYSTEM; Sensor nível de água; Ligação equipotencial; Interruptor diferencial monofásico proteção 25A/30mA - 240V - 50Hz; 2 anos de garantia contra defeitos de fabrico. Disponível em cromado.

6 lateral swivelling water jets in ABS; Electronic control 3 functions: on/off water massage, automatic water interval and manual air control; Suction strainer in ABS; 650w IP54 230-240-V 3A jet pump or 800W IP54 230-240-V 3A jet pump (with micros); Automatic discharge valve; KOLLER SYSTEM electronic control panel; Water level sensor; Equipotential connection; Residual current operator circuit breaker (RCCB) 25A/30mA - 240V - 50Hz; 2 years guarantee against manufacture defects. Available in chromed.



Eletrónico Kombi ABS  
Kombi electronic ABS



6 injetores de água laterais orientáveis em ABS; 10 injetores inferiores em ABS; Comando eletrónico de 3 funções: on/off massagem de água, intermitência automática de água e regulação manual de caudal (mistura de ar); Inversor 2 vias com 3 posições: massagem lateral, massagem inferior ou funcionamento de ambas em simultâneo; Crivo de sucção ABS; Motor 650w IP54 230-240-V 3A ou 800W IP54 230-240-V 3A (com micros); Válvula de descarga automática com dreno; Quadro controlo eletrónico KOLLER SYSTEM; Sensor nível de água eletrónico; Ligação equipotencial; Interruptor diferencial monofásico proteção 25A/30mA - 240V - 50Hz; 2 anos de garantia contra defeitos de fabrico. Disponível em cromado.

6 lateral swivelling jets in ABS; 10 lower jets in ABS; Electronic control 3 functions: on/off water massage, automatic water interval and manual air control, 2 way inverter with 3 positions: side massage, lower massage or simultaneous operation of both; Suction strainer in ABS; 650w IP54 230-240-V 3A jet pump or 800W IP54 230-240-V 3A jet pump (with micros); Automatic discharge valve with drain; KOLLER SYSTEM Electronic control panel; Electronic water level sensor; Equipotential connection; Residual current operator circuit breaker (RCCB) 25A/30mA - 240V - 50Hz; 2 years guarantee against manufacture defects. Available in chromed.



Pneumático duplo ABS  
Double pneumatic ABS



6 injetores de água laterais orientáveis em ABS; 10 injetores de ar em ABS; Comando pneumático 2 funções: on/off massagem de água e regulação manual de caudal (mistura de ar); Comando pneumático on/off massagem de ar; Crivo de sucção ABS; Motor 650w IP54 230-240-V 3A/ 800W IP54 230-240-V 3A (com micros); Compressor 830W IPX5 230-240-V 4.2A com aquecimento; Válvula de descarga automática com dreno; Quadro controlo pneumático com sensor nível de água; Ligação equipotencial; Interruptor diferencial monofásico proteção 25A/30mA - 240V - 50Hz; 2 anos de garantia contra defeitos de fabrico. Disponível em cromado.

6 lateral swivelling water jets in ABS; 10 air jets in ABS; Pneumatic press button control 2 functions: on/off water massage and manual air control; Suction strainer in ABS; 650w IP54 230-240-V 3A jet pump or 800w IP54 230-240-V 3A jet pump (with micros); 830W IPX5 230-240-V 4.2A blower with heating; Automatic discharge valve with drain; Pneumatic control panel with water level sensor; Equipotential connection; Residual current operator circuit breaker (RCCB) 25A/30mA - 240V - 50Hz; 2 years guarantee against manufacture defects. Available in chromed.



Eletrónico duplo ABS  
Double electronic ABS



6 injetores de água laterais orientáveis em ABS; 10 injetores de ar em ABS; Comando eletrónico de 4 funções: on/off massagem de água e ar, seleção +/- intensidade massagem de água e ar, intermitência automática da massagem de água, variação automática de intensidade da massagem de ar; Regulador manual de caudal (mistura de ar); Crivo de sucção ABS; Motor 650W IP54 230-240-V 3A ou 800W IP54 230-240-V 3A (com micros); Compressor 830W IPX 230-240-V 4.2A com aquecimento; Válvula de descarga automática com dreno; Quadro controlo eletrónico KOLLER SYSTEM; Sensor nível de água eletrónico; Ligação equipotencial; Interruptor diferencial monofásico proteção 24A/30mA - 240V - 50 Hz; 2 anos de garantia contra defeitos de fabrico. Disponível em cromado.

6 lateral swivelling water jets ABS; 10 air jets in ABS; Electronic control 4 functions: on/off water and air massage, +/- water and air intensity, automatic water interval, automatic variation of air intensity; Manual air control; Suction strainer in ABS; 650W IP54 230-240-V 3A jet pump or 800W IP54 230-240-V 3A jet pump (with micros); 830W IPX5 230-240-V 4.2A blower with heating; Automatic discharge valve with drain; KOLLER SYSTEM electronic control panel; Electronic water level sensor; Equipotential connexion; Residual current operator circuit breaker (RCCB) 25A/30mA - 240V - 50Hz; 2 years guarantee against manufacture defects. Available in chromed.



Eletrónico duplo Flat latão  
Double electronic Flat brass



6 injetores de água laterais orientáveis Flat em latão; 10 injetores de ar Flat em latão; Comando eletrónico Flat 4 funções: on/off massagem de água e ar, seleção +/- intensidade massagem de água e ar, intermitência automática da massagem de água, variação automática de intensidade da massagem de ar; Regulador manual de caudal quadrado (mistura de ar); Crivo de sucção Flat; Motor 650w IP54 230-240-V 3A/ 800W IP54 230-240-V 3A (com micros); Compressor 830W IPX5 230-240-V 4.2A com aquecimento; Válvula de descarga automática Flat com dreno; Quadro controlo eletrónico KOLLER SYSTEM; Sensor nível de água eletrónico; Ligação equipotencial; Interruptor diferencial monofásico proteção 25A/30mA - 240V - 50Hz; 2 anos de garantia contra defeitos de fabrico. Disponível em cromado.

6 lateral brass swivelling water jets Flat; 10 brass air jets Flat; Electronic control 4 functions: on/off water and air massage, +/- water and air intensity, automatic water interval, automatic variation of air intensity; Square manual air control; Suction strainer; 650w IP54 230-240-V 3A jet pump or 800w IP54 230-240-V 3A jet pump (with micros); 830W IPX5 230-240-V 4.2A blower with heating; Automatic discharge valve Flat with drain; KOLLER SYSTEM electronic control panel; Electronic water level sensor; Equipotential connection; Residual current operator circuit breaker (RCCB) 25A/30mA - 240V - 50Hz; 2 years guarantee against manufacture defects. Available in chromed.



## ⇒ BECOOL FREESTANDING

Graciosa e límpida, são os adjectivos para este lugar de descanso. De formas únicas e altamente decorativa a banheira Becool é um objecto de linhas estreitas e sinuosas que confere uma dinâmica visual excepcional a qualquer espaço.

Graceful and limpid are the adjectives for this resting place. Uniquely shaped and highly decorative, the Becool bathtub is an object with narrow and sinuous lines that gives an exceptional visual dynamic to any space.

B ↓ A →

1600x800

1700x800

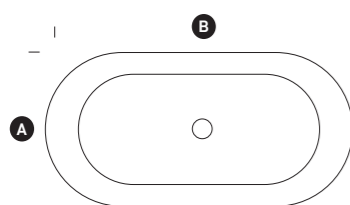

Solid surface	1600x800	1700x800
Poliéster acrílico modificado	.	.
Acrylic modified polyester	0605201016080	0605201017080

Dados técnicos - Technical data - P106





## » OVAL FREESTANDING

A banheira Oval traz a estrutura perfeita para cada ambiente, seguindo a máxima de que a forma segue a função. Com design minimalista traz tranquilidade e clareza a qualquer ambiente.

The Oval bathtub brings the perfect structure for every environment, following the maxim of form follows function. The minimalist design brings tranquility and clarity to any environment..

**B** ↓ **A** →

1690x780

1790x790

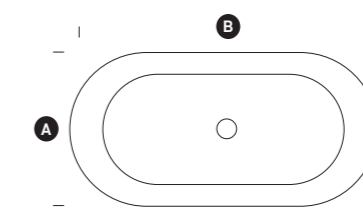

**1690x780**

**1790x790**

Acrílico Lucite  
Acrylic Lucite

0605181016978

0605181017979

Dados técnicos - Technical data - P106



## »> TENDENCE FREESTANDING

A banheira Tendence transforma todos os desejos em realidade. Com formas adaptadas ao relaxamento, facilmente satisfaz a necessidade de criar um espaço único.

The Tendence bathtub makes all wishes come true. With shapes adapted to relaxation, it easily satisfies the need to create a unique space.

**B** ↓ **A** →

1800x800

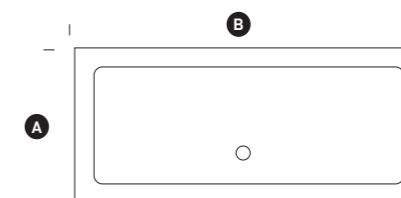

1800x800

Acrílico Lucite  
Acrylic Lucite

0605171018080

Dados técnicos - Technical data - P106



## » ART EPOQUE FREESTANDING

De formas clássicas, a banheira Art Epoque fornece a base perfeita para criar um espaço diferente e de inspiração vintage.

With classic shapes, the Art Epoque bathtub provides the perfect base for creating a different and vintage-inspired space.

**B** ↓ **A** →

1790x780

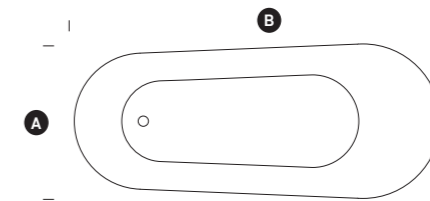

1790x780

Acrílico Lucite  
Acrylic Lucite

0605191017978

Dados técnicos - Technical data - P106

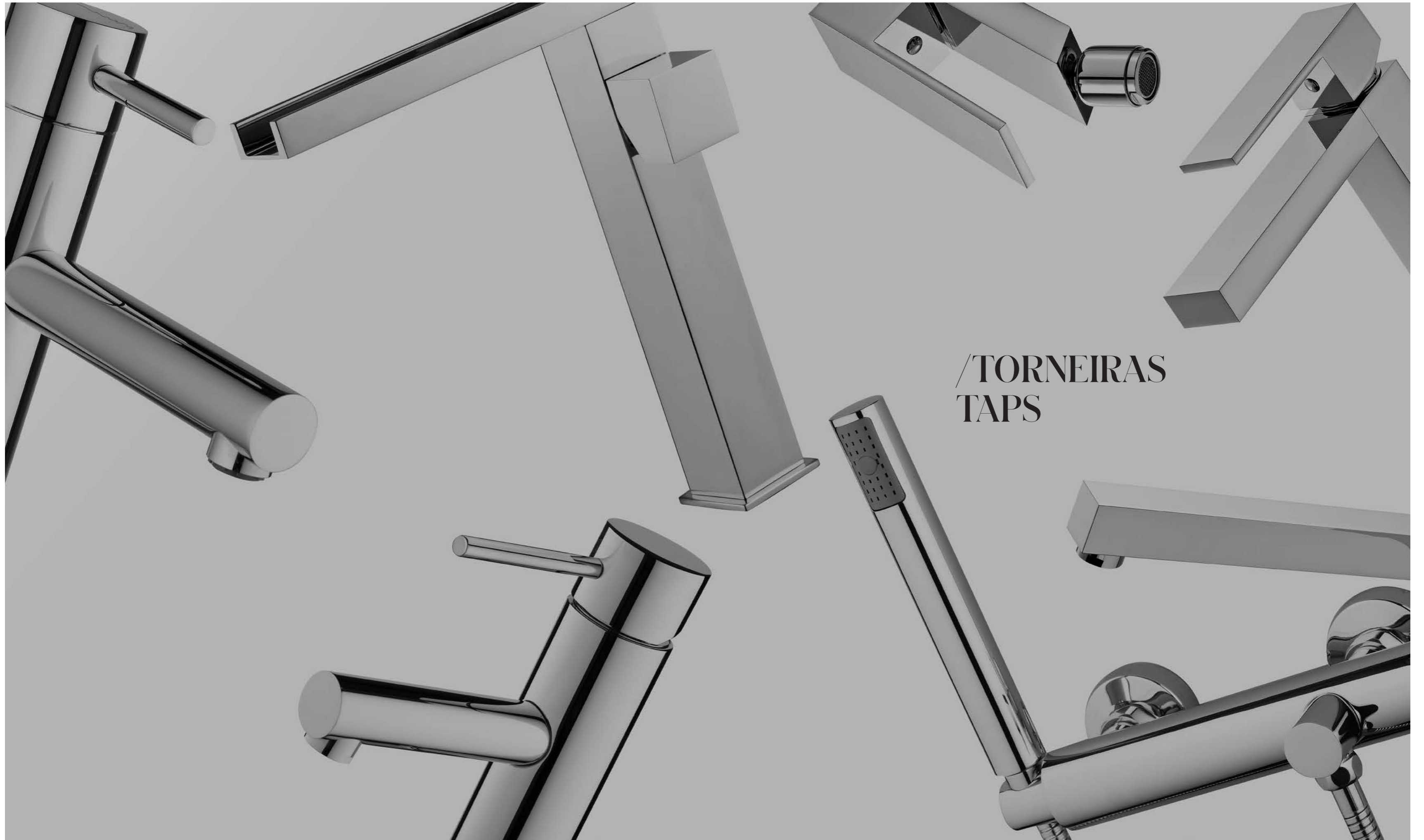

/TORNEIRAS  
TAPS

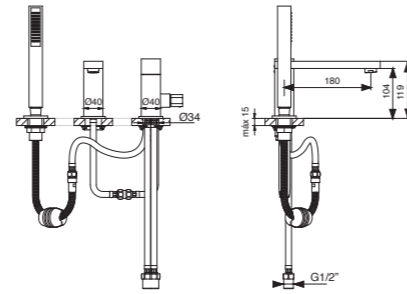

Quadra	Cromado	Branco	Preto
Monocomando banheira 3 furos 3 hole single lever bathtub mixer	010ESQ110	010ESQ11001	010ESQ11002
Conjunto antigotas quadrado Square anti-drops set	5631001	56310011	56310012

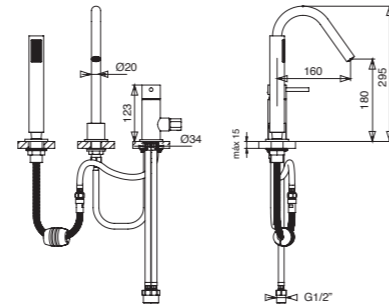

Slim	Cromado	Branco	Preto
Monocomando 3 furos 3 Hole single lever bathtub mixer	010SLIM110	010SLIM11001	010SLIM11002
Conjunto antigotas redondo Round anti-drops set	5631002	56310021	56310022

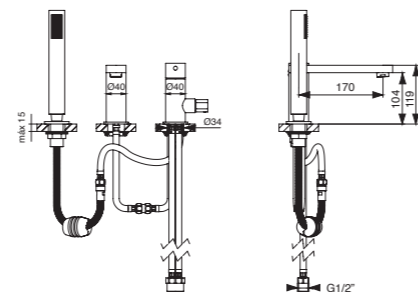

Cilíndrica	Cromado	Branco	Preto
Monocomando 3 furos 3 Hole single lever bathtub mixer	010CIL115	010CIL11501	010CIL11502
Conjunto antigotas redondo Round anti-drops set	5631002	56310021	56310022

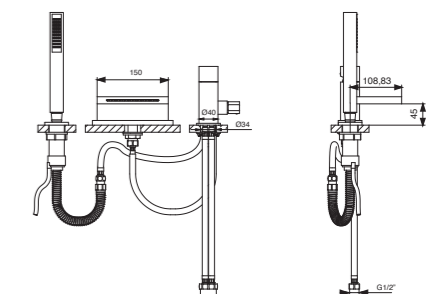

Extraplana	Cromado	Branco	Preto
Monocomando 3 furos 3 Hole single lever bathtub mixer	010CAS110	010CAS11001	010CAS11002
Conjunto antigotas quadrado Square anti-drops set	5631001	56310011	56310012

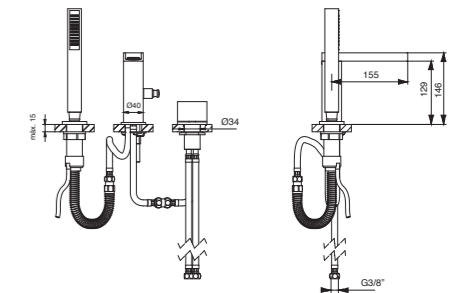

Nascente	Cromado	Branco	Preto
Monocomando 3 furos 3 Hole single lever bathtub mixer	010NAS110	010NAS11001	010NAS11002
Conjunto antigotas quadrado Square anti-drops set	5631001	56310011	56310012

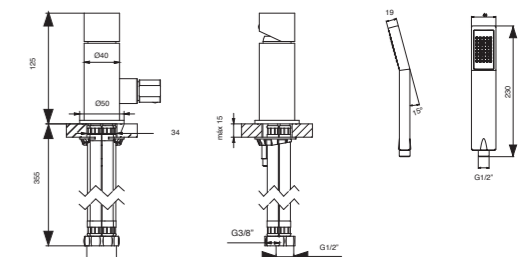

Cascaata encastrar - Built-it flat spout	Cromado
Monocomando, chuveiro mão e bica de encastrar Single lever mixer and hand shower and built-it flat spout	010CASC11001
Conjunto antigotas quadrado Square anti-drops set	5631001



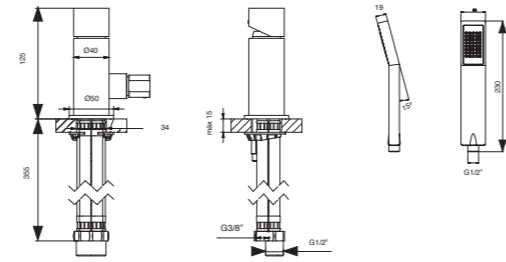

Quadra	Cromado
Monocomando, chuveiro de mão e válvula de enchimento com descarga automática Single lever mixer, hand shower, pop-up waste and overflow with water outlet spot.	010QUAD11001
Conjunto antigotas quadrado Square anti-drops	5631001

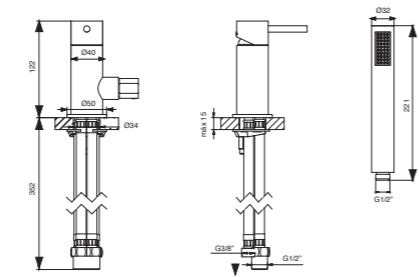

Cilíndrico	Cromado
Monocomando, chuveiro de mão e válvula de enchimento com descarga automática. Single lever mixer, hand shower and pop-up waste and overflow with water outlet spot.	010CIL11001
Conjunto antigotas redondo Round anti-drops set	5631002

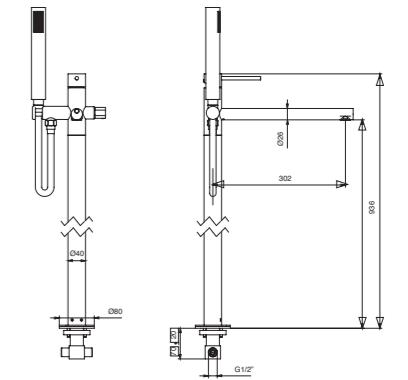

Quadra chão	Cromado	Branco	Preto
Monocomando de banheira ao chão com chuveiro manual Bathtub single-lever mixer floor mounting with waterfall spout, diverter and shower hand.	010ESQ15500	010ESQ15501	010ESQ15502

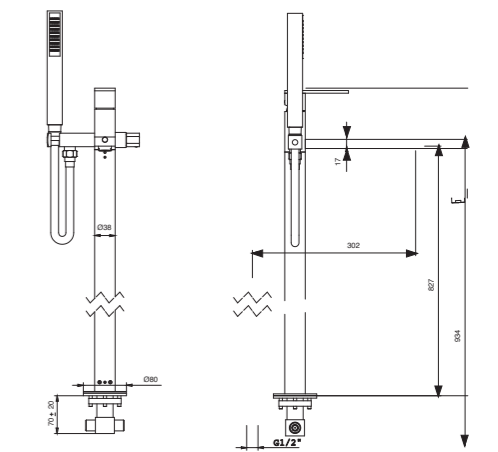

Cilíndrica chão	Cromado	Branco	Preto
Monocomando de banheira ao chão com chuveiro manual Bathtub single-lever mixer floor mounting with waterfall spout, diverter and shower hand.	010CIL15500	010CIL15501	010CIL15502

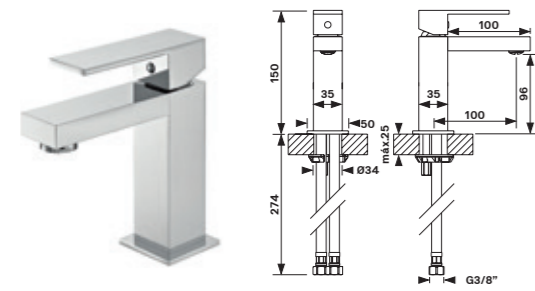

Plan	Cromado	Branco	Preto
Monocomando lavatório (Inclui válvula clic clac + 2 Torneiras esquadria 1/2*3/8 Com filtro) Single lever basin mixer (click-clack waste and tap 1/2x3/8 with filter)	010PLAN011	010PLAN012	010PLAN013

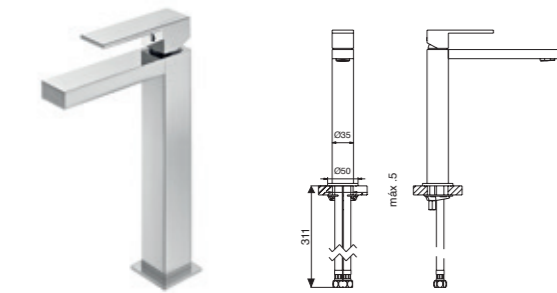

Plan	Cromado	Branco	Preto
Monocomando lavatório 180mm (Inclui válvula clic clac + 2 Torneiras esquadria 1/2*3/8 Com filtro) Single lever basin mixer 180mm (click-clack waste and tap 1/2x3/8 with filter)	010PLAN51A1	010PLAN51A2	010PLAN51A3

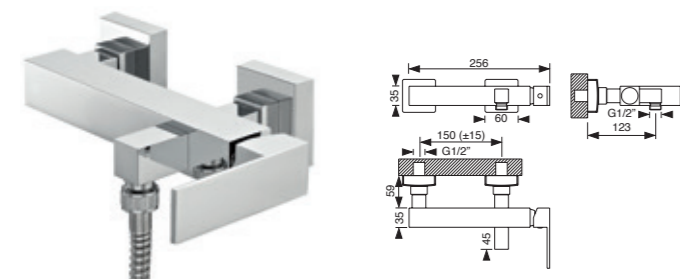

Plan	Cromado	Branco	Preto
Monocomando ducha, chuveiro de mão, suporte e flexível Shower mixer, hand-shower, flexible and support	010PLAN0301	010PLAN0302	010PLAN0303

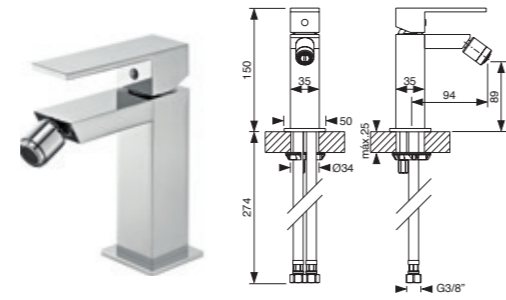

Plan	Cromado	Branco	Preto
Monocomando bidê (Inclui válvula clic clac + 2 torneiras esquadria 1/2*3/8 com filtro) Single lever bidet mixer (click-clack waste and tap 1/2x3/8 with filter)	010PLAN0201	010PLAN0202	010PLAN0203

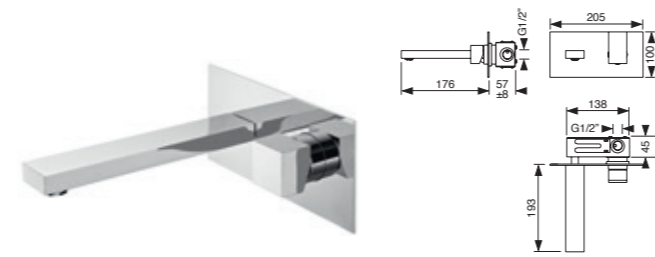

Plan	Cromado	Branco	Preto
Monocomando lavatório de parede com espelho completo Single lever built-in basin mixer with wall flange	010ESQ0701	010ESQ0702	010ESQ0703

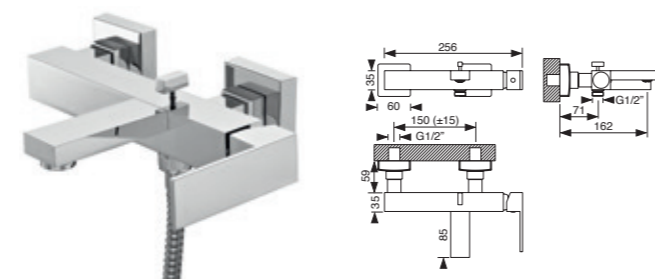

Plan	Cromado	Branco	Preto
Monocomando banheira com bica, inversor, chuveiro de mão, suporte e flexível Bath mixer with spout, diverter, hand-shower, flexible and support	010PLAN0401	010PLAN0402	010PLAN0403

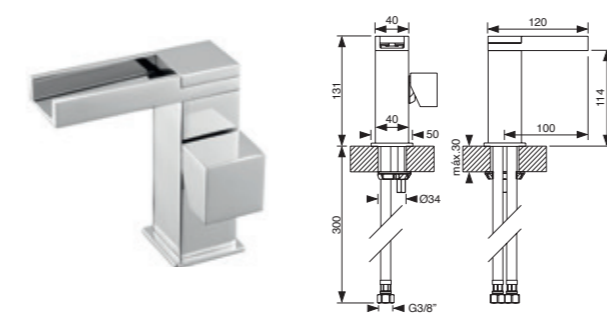

Nascente	Cromado	Branco	Preto
Monocomando lavatório (inclui válvula clic clac + 2 torneiras esquadria 1/2*3/8 com filtro) Single-lever basin mixer (click-clack waste and tap 1/2x3/8 with filter)	010NAS101	010NAS102	010NAS103

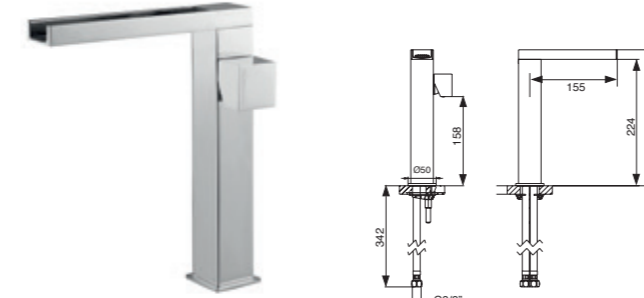

Nascente	Cromado	Branco	Preto
Monocomando lavatório 175mm (inclui válvula clic clac + 2 torneiras esquadria 1/2*3/8 com filtro) Single-lever basin mixer 175mm (click-clack waste and tap 1/2x3/8 with filter)	010NAS0511	010NAS0512	010NAS0513

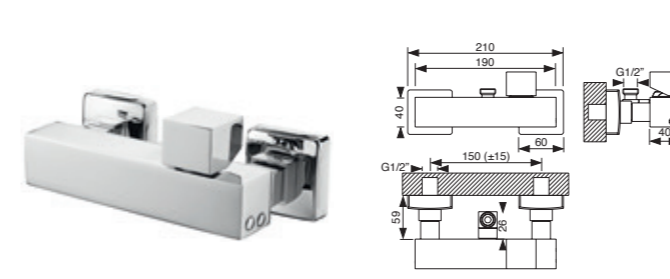

Nascente	Cromado	Branco	Preto
Monocomando ducha, chuveiro de mão, suporte e flexível Shower mixer, hand-shower, flexible and support	010PLAN0301	010PLAN0302	010NAS303

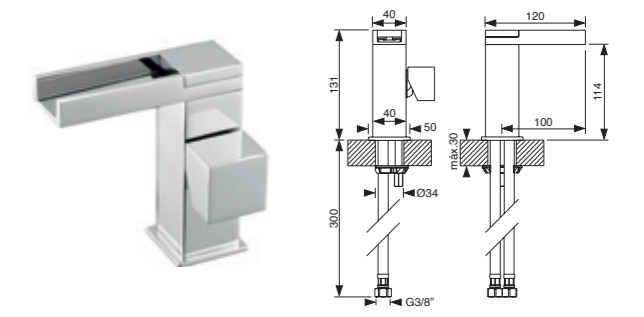

Nascente	Cromado	Branco	Preto
Monocomando bidê (inclui válvula clic clac + 2 torneiras esquadria 1/2*3/8 com filtro) Single lever bidet mixer (click-clack waste and tap 1/2x3/8 with filter)	010NAS201	010NAS202	010NAS203

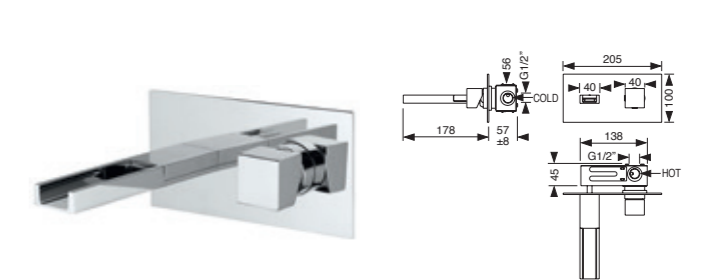

Nascente	Cromado	Branco	Preto
Monocomando lavatório de parede com espelho completo Single lever built-in basin mixer with wall flange	010NAS0701	010NAS0702	010NAS0703

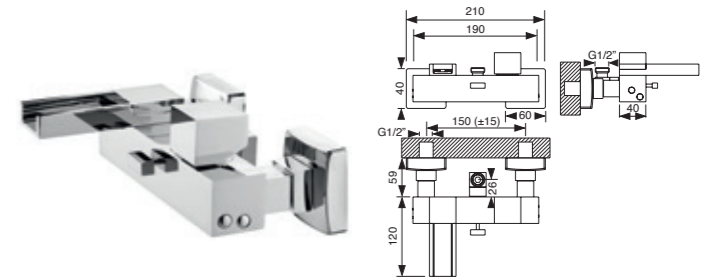

Nascente	Cromado	Branco	Preto
Monocomando banheira com bica, inversor, chuveiro de mão, suporte e flexível Bath mixer with spout, diverter, hand-shower, flexible and support	010NAS401	010NAS402	010NAS403

Quadra →

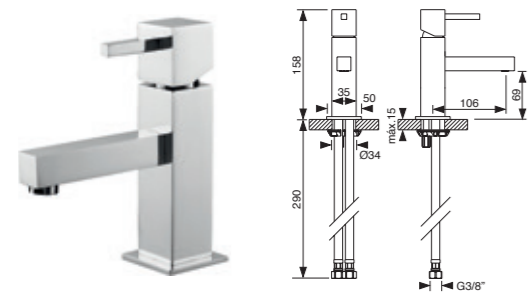

Quadra	Cromado	Branco	Preto
Monocomando lavatório com perno (Inclui válvula clic clac + 2 torneiras esquadria 1/2*3/8 com filtro) Basin mixer, with bolt (click-clack waste and tap 1/2x3/8 with filter)	010QUAD01R1	010QUAD01R2	010QUAD01R3

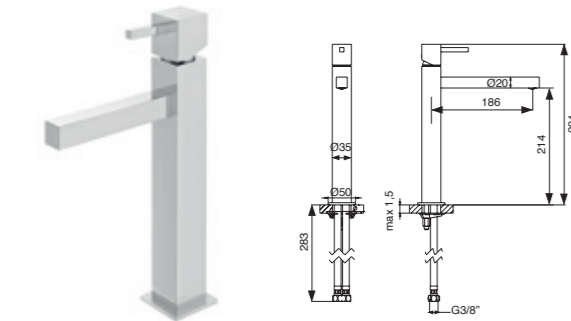

Quadra	Cromado	Branco	Preto
Monocomando lavatório 180mm com perno (Inclui válvula clic clac + 2 torneiras esquadria 1/2*3/8 com filtro) Basin mixer 180mm, with bolt (click-clack waste and tap 1/2x3/8 with filter)	010QUAD51BR1	010QUAD51BR2	010QUAD51BR3

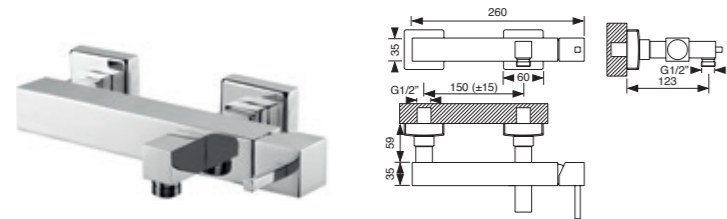

Quadra	Cromado	Branco	Preto
Monocomando duche, com perno, chuveiro de mão, suporte e flexível Shower mixer, with bolt, hand-shower, flexible and support	010QUAD30R1	010QUAD30R2	010QUAD30R3

Quadra	Cromado	Branco	Preto
Monocomando bidé com perno (Inclui válvula clic clac + 2 torneiras esquadria 1/2*3/8 com filtro) Single lever bidet mixer, with bolt (click-clack waste and tap 1/2x3/8 with filter)	010QUAD20R1	010QUAD20R2	010QUAD20R3

Cilíndrica →

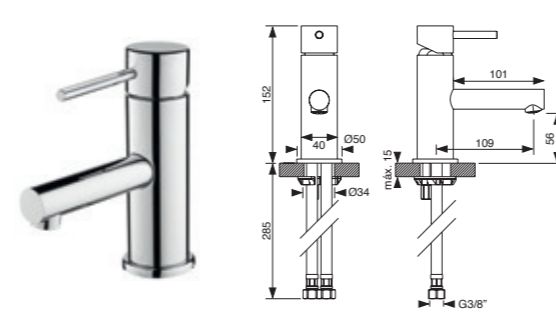

Cilíndrica	Cromado	Branco	Preto
Monocomando lavatório com perno (Inclui válvula clic clac + 2 torneiras esquadria 1/2*3/8 com filtro) Basin mixer, with bolt (click-clack waste and tap 1/2x3/8 with filter)	010CIL10R1	010CIL10R2	010CIL10R3

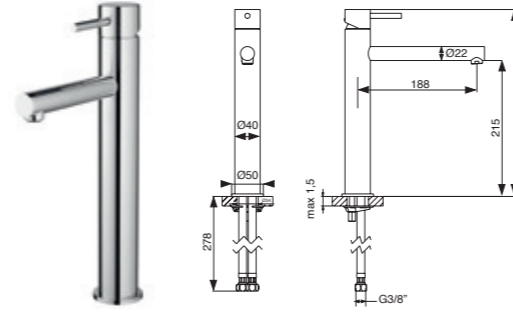

Cilíndrica	Cromado	Branco	Preto
Monocomando lavatório 180mm com perno (Inclui válvula clic clac + 2 torneiras esquadria 1/2*3/8 com filtro) Basin mixer 180mm, with bolt (click-clack waste and tap 1/2x3/8 with filter)	010CIL51AR1	010CIL51AR2	010CIL51AR3

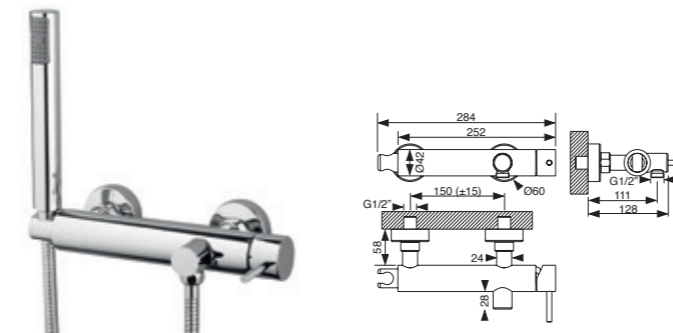

Cilíndrica	Cromado	Branco	Preto
Monocomando duche, com perno, chuveiro de mão, suporte e flexível Shower mixer, with bolt, hand-shower, Flexible and support	010CIL30R1	010CIL30R2	010CIL30R3

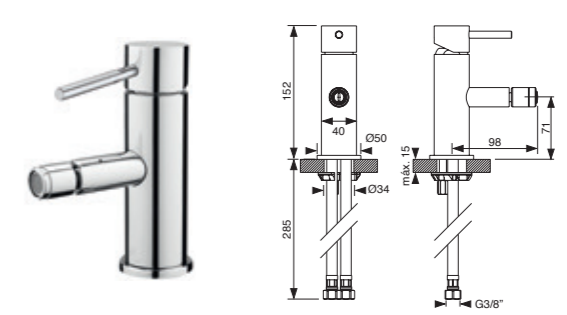

Cilíndrica	Cromado	Branco	Preto
Monocomando bidé com perno (Inclui válvula clic clac + 2 torneiras esquadria 1/2*3/8 com filtro) Single lever bidet mixer, with bolt (click-clack waste and tap 1/2x3/8 with filter)	010CIL20R1	010CIL20R2	010CIL20R3

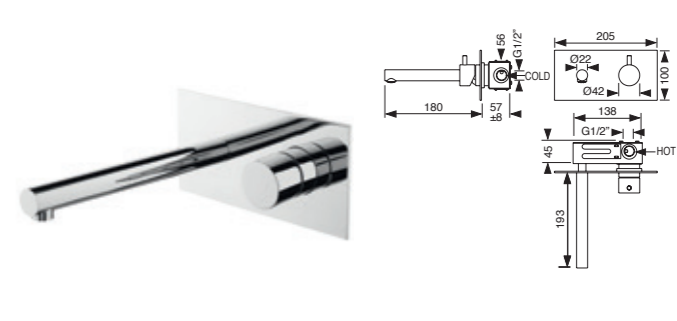

Cilíndrica	Cromado	Branco	Preto
Monocomando lavatório de parede com espelho completo Single lever built-in basin mixer with wall flange	010CIL0701	010CIL0702	010CIL0703

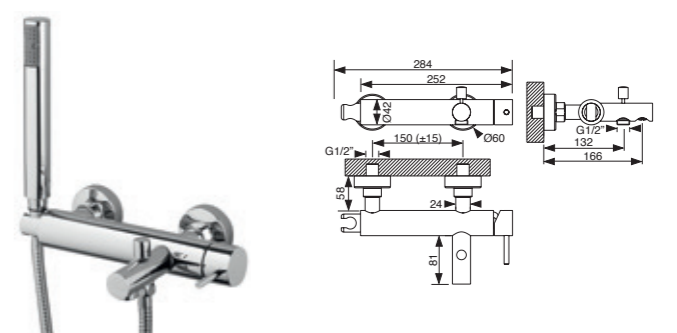

Cilíndrica	Cromado	Branco	Preto
Monocomando banheira com bica, inversor, chuveiro de mão, suporte e flexível Bath mixer with bolt, spout, diverter, hand-shower, flexible and support	010CIL40R1	010CIL40R2	010CIL40R3

# /COLUNAS COLUMNS



Cilíndrica - Quadra →

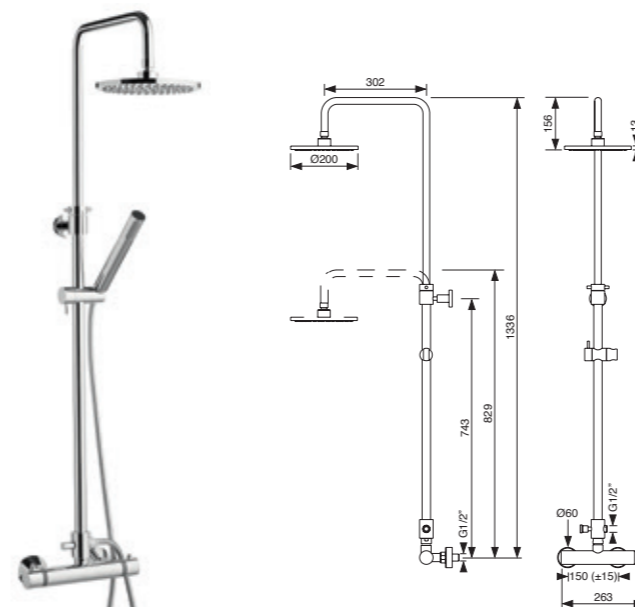

Cilíndrica termostática	Cromado	Branco	Preto
Coluna duche com inversor integrado Shower column with integrated diverter	07220011	--	07220013

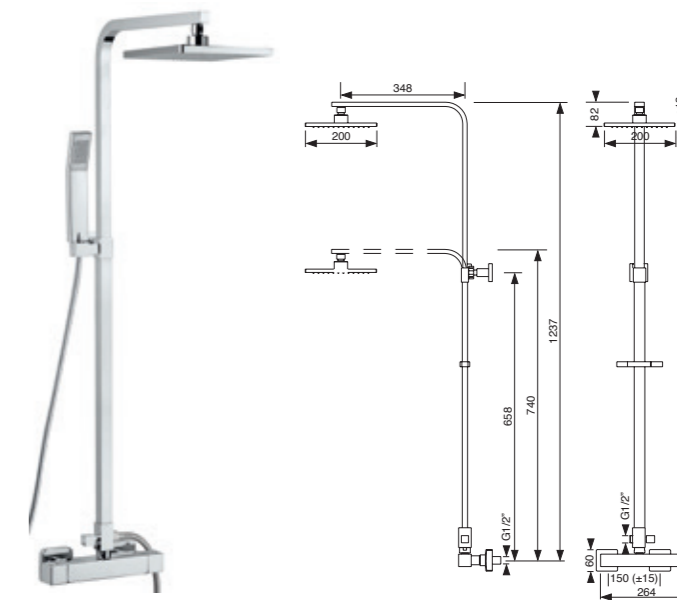

Quadra termostática	Cromado	Branco	Preto
Coluna duche com inversor integrado Shower column with integrated diverter	07220101	--	07220103

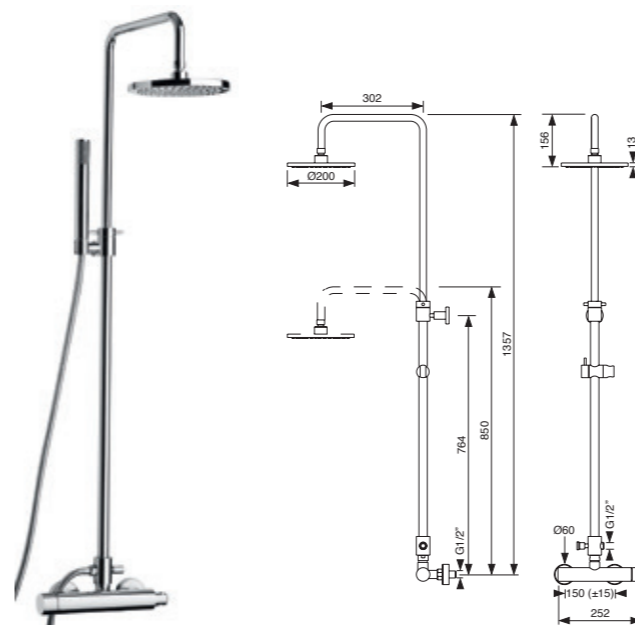

Cilíndrica monocomando	Cromado	Branco	Preto
Coluna duche com inversor integrado Shower column with integrated diverter	07210011	--	07210013

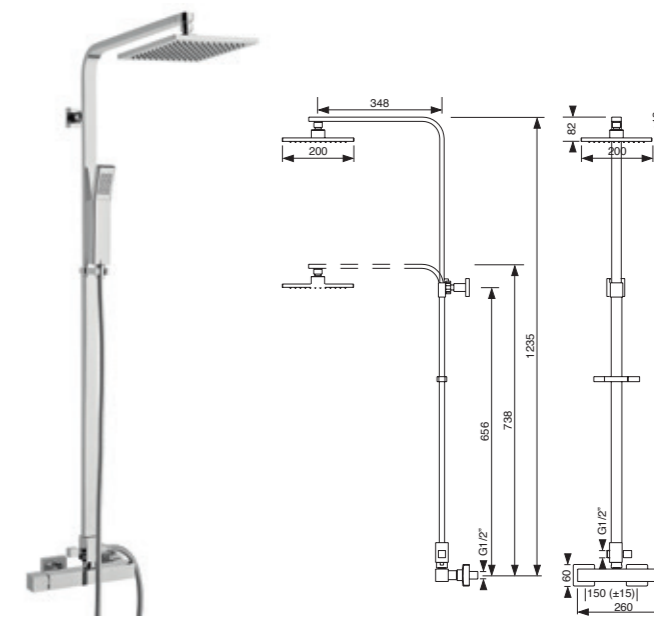

Quadra monocomando	Cromado	Branco	Preto
Coluna duche com inversor integrado Shower column with integrated diverter	07210101	--	07210103

Produção por encomenda, prazo de entrega 4 semanas | Make to order, delivery 4 weeks.



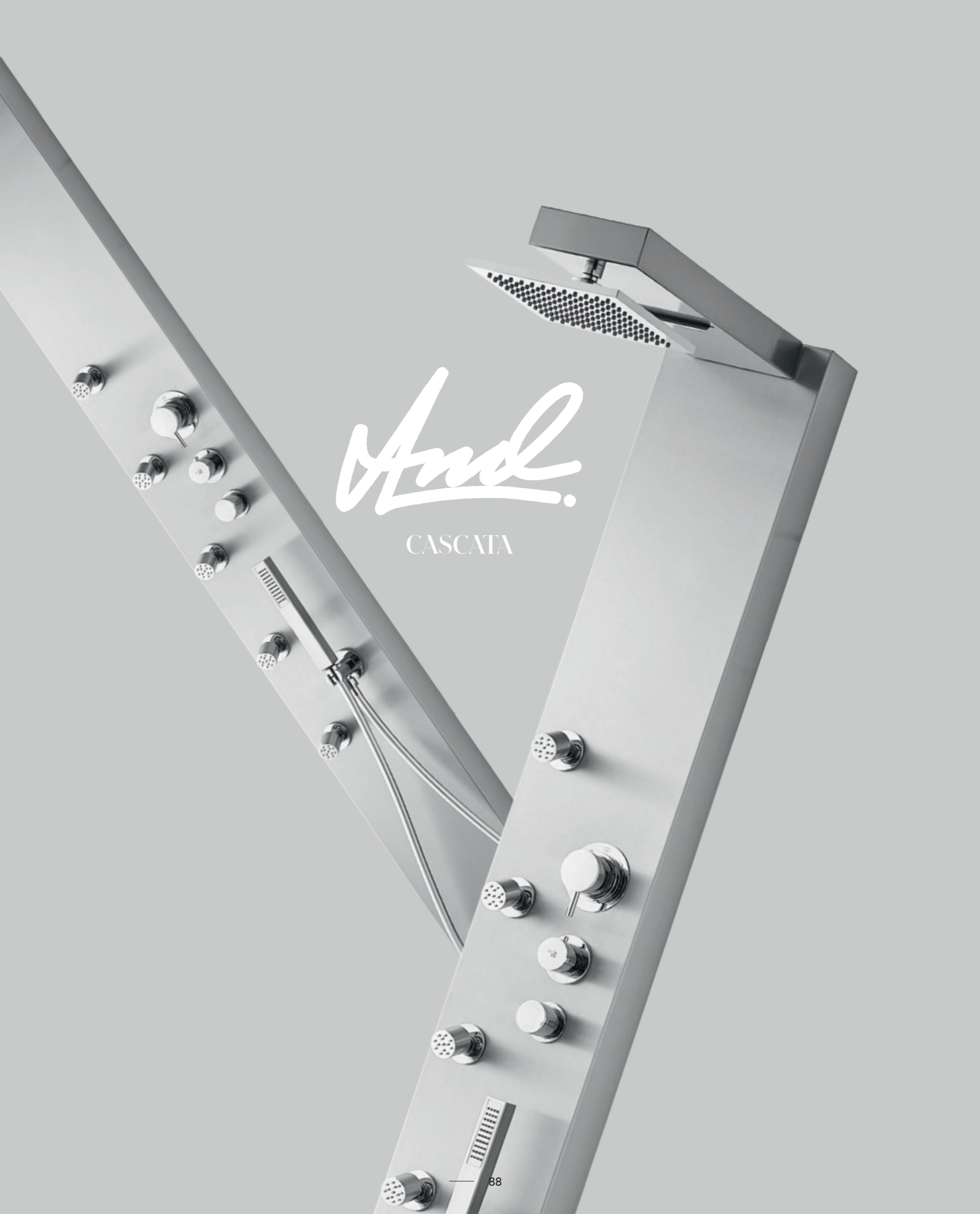

*And.*

CASCATA

## ⇒ CASCATA 1500

Misturadora termostática;  
 Seletor manual 3 funções com regulador de caudal;  
 Controle de temperatura com bloqueio de segurança nos 38°C;  
 4 Jatos de hidromassagem orientáveis;  
 Braço de inox com cascata incorporada;  
 Chuveiro fixo "efeito rain" quadrado 200x200mm com 144 orifícios (20l/3bar);  
 Chuveiro de mão retangular com suporte chuveiro e tubo flexível;  
 Possibilidade de instalação em canto a pedido.

Thermostatic mixer;  
 3 functions manual selector with flow regulator;  
 Temperature control with safety stop at 38°C;  
 4 Directional whirlpool jets;  
 Stainless steel arm with built-in waterfall;  
 "Rain-effect" overhead shower square 200x200mm with 144 holes (20l/3bar);  
 Rectangular hand shower with showerhead support and flexible hose;  
 Possibility of corner installation on request.

<b>Corpo inox escovado</b> Brushed stainless steel structure	1500x220x81	123103
<b>Corpo inox escovado + placa acrílica branca</b> Brushed stainless steel structure + white acrylic sheet	1530x250x87	123105



## ⇒ CASCATA 1800

Misturadora termostática;  
 Seletor manual 5 funções com regulador de caudal;  
 Controle de temperatura com bloqueio de segurança nos 38°C;  
 5 Jatos de hidromassagem orientáveis;  
 Braço de inox com cascata incorporada;  
 Chuveiro fixo "efeito rain" quadrado 200x200mm com 144 orifícios (20l/3bar);  
 Chuveiro de mão retangular com suporte chuveiro e tubo flexível;  
 Chuveiro para os pés;  
 Possibilidade de instalação em canto a pedido.

Thermostatic mixer;  
 5 functions manual selector with flow regulator;  
 Temperature control with safety stop at 38°C;  
 5 directional whirlpool jets;  
 Stainless steel arm with built-in waterfall;  
 "Rain-effect" overhead shower square 200x200mm with 144 holes (20l/3bar);  
 Rectangular hand shower with showerhead support and flexible hose;  
 Foot shower;  
 Possibility of corner installation on request.

<b>Corpo inox escovado</b> Brushed stainless steel structure	1800x220x81	123104
<b>Corpo inox escovado + placa acrílica branca</b> Brushed stainless steel structure + white acrylic sheet	1830x250x87	123106





## ⇒ INOX 2000

Corpo em aço inox escovado (com opção placa de acrílico branco);  
 Misturadora termostática e seletor manual de 5 funções com regulador de caudal;  
 Bloqueio de temperatura aos 38°C;  
 5 Jatos de hidromassagem orientáveis;  
 Chuveiro fixo "efeito rain" quadrado 200x200mm com 144 orifícios (20l/3bar);  
 Chuveiro de mão retangular com suporte de chuveiro e tubo flexível;  
 Chuveiro para os pés;  
 Possibilidade de instalação em canto a pedido.

Brushed stainless steel structure (with white acrylic sheet optional);  
 Thermostatic mixer and 5 functions manual selector with flow regulator;  
 Temperature control with safety stop at 38°C;  
 5 Directional hydromassage jets;  
 "Rain-effect" overhead shower square 200x200mm with 144 holes (20l/3bar);  
 Rectangular hand shower with showerhead support and flexible hose;  
 Foot shower;  
 Possibility of corner installation on request.

<b>Corpo inox escovado + faixa de madeira</b> Brushed stainless steel structure	2000x330x81	123002X
<b>Corpo inox escovado + placa acrílica branca</b> Brushed stainless steel structure + white acrylic sheet	2030x350x87	1230020

Substituir X pelo acabamento em Fenólico - Replace X with the finish in Phenolic

### Faixa em fenólico Phenolic strip



Wengué (4)



Castanho (1) - Brown



Mel (3) - Honey



Faia (2) - Beech



»> INOX  
1500

Misturadora termostática;  
 Seletor manual 3 funções com regulador de caudal;  
 Controle de temperatura com bloqueio de segurança nos 38°C;  
 4 Jatos de hidromassagem orientáveis;  
 Chuveiro fixo "efeito rain" quadrado 200x200mm com 144 orifícios (20l/3bar);  
 Chuveiro de mão retangular com suporte de chuveiro e tubo flexível;  
 Possibilidade de instalação em canto a pedido.

Thermostatic mixer;  
 3 functions manual selector with flow regulator;  
 Temperature control with safety stop at 38°C;  
 4 Directional whirlpool jets;  
 "Rain-effect" overhead shower square 200x200mm with 144 holes (20l/3bar);  
 Rectangular hand shower with showerhead support and flexible hose;  
 Possibility of corner installation on request.

<b>Corpo inox escovado</b>	1500x220x81	-
Brushed stainless steel structure		123003
<b>Corpo inox escovado + placa acrílico branca</b>	1530x250x87	-
Brushed stainless steel structure + white acrylic sheet		123005



»> INOX  
1800

Misturadora termostática;  
 Seletor manual 5 funções com regulador de caudal;  
 Controle de temperatura com bloqueio de segurança nos 38°C;  
 5 Jatos de hidromassagem orientáveis;  
 Chuveiro fixo "efeito rain" quadrado 200x200mm com 144 orifícios (20l/3bar);  
 Chuveiro de mão retangular com suporte chuveiro e tubo flexível;  
 Chuveiros de pés;  
 Possibilidade de instalação em canto a pedido.

Thermostatic mixer;  
 5 functions manual selector with flow regulator;  
 Temperature control with safety stop at 38°C;  
 5 Directional whirlpool jets;  
 "Rain-effect" overhead shower square 200x200mm with 144 holes (20l/3bar);  
 Rectangular hand shower with showerhead support and flexible hose;  
 Feet shower;  
 Possibility of corner installation on request.

<b>Corpo inox escovado</b>	1800x220x81	-
Brushed stainless steel structure		123004
<b>Corpo inox escovado + placa acrílico branca</b>	1830x250x87	-
Brushed stainless steel structure + white acrylic sheet		123006







## » INOX BANHEIRA

Misturadora termostática;  
 Seletor manual 3 funções com regulador de caudal;  
 Controle de temperatura com bloqueio de segurança nos 38°C;  
 4 Jatos de hidromassagem orientáveis;  
 Chuveiro fixo quadrado;  
 Chuveiro de mão retangular com suporte de chuveiro e tubo flexível;  
 Bica com controle de caudal e abundante fluxo de água.

Thermostatic mixer;  
 3 functions manual selector with flow regulator;  
 Temperature control with safety stop at 38°C;  
 4 Directional whirlpool jets;  
 Square showerhead;  
 Rectangular hand shower with showerhead support and flexible hose;  
 Spout with flow control and abundant water outlet.

<b>Corpo inox escovado</b> Brushed stainless steel structure	1500x220x81	123010
<b>Corpo inox escovado + placa acrílica branca</b> Brushed stainless steel structure + white acrylic sheet	1530x250x87	123011





*The.*  
ECO

## »» ECO 1500

Misturadora termostática;  
 Seletor manual 3 funções com regulador de caudal;  
 Controle de temperatura com bloqueio de segurança nos 38°C;  
 6 Jatos de hidromassagem orientáveis;  
 Chuveiro fixo "efeito rain" cilíndrico Ø200mm com 144 orifícios (20l/3bar);  
 Chuveiro de mão retangular com suporte de chuveiro e tubo flexível;  
 Possibilidade de instalação em canto a pedido.

Thermostatic mixer;  
 3 functions manual selector with flow regulator;  
 Temperature control with safety stop at 38°C;  
 6 Directional whirlpool jets;  
 "Rain-effect" overhead shower cylindrical Ø200mm with 144 holes (20l/3bar);  
 Rectangular hand shower with showerhead support and flexible hose;  
 Possibility of corner installation on request.

<b>Corpo inox escovado</b> Brushed stainless steel structure	1500x220x81	124003
<b>Corpo inox escovado + placa acrílico branca</b> Brushed stainless steel structure + white acrylic sheet	1530x250x87	124011



## »» ECO 1800













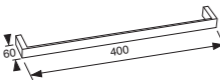

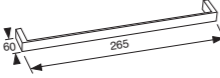



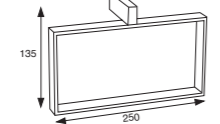

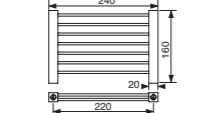

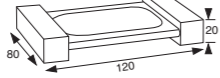

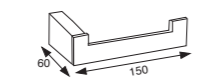
Misturadora termostática;  
 Seletor manual 5 funções com regulador de caudal;  
 Controle de temperatura com bloqueio de segurança nos 38°C;  
 6 Jatos de hidromassagem orientáveis;  
 Chuveiro fixo "efeito rain" cilíndrico Ø200mm com 144 orifícios (20l/3bar);  
 Chuveiro de mão retangular com suporte de chuveiro e tubo flexível;  
 Chuveiro para os pés;  
 Possibilidade de instalação em canto a pedido.

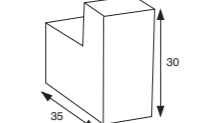
Thermostatic mixer;  
 5 functions manual selector with flow regulator;  
 Temperature control with safety stop at 38°C;  
 6 Directional whirlpool jets;  
 "Rain-effect" overhead shower cylindrical Ø200mm with 144 holes (20l/3bar);  
 Rectangular hand shower with showerhead support and flexible hose;  
 Foot shower;  
 Possibility of corner installation on request.

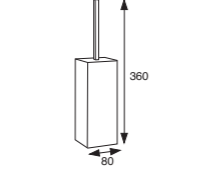

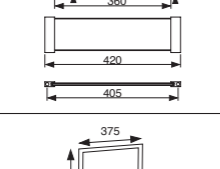

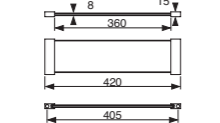

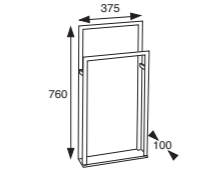







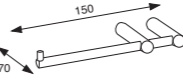

<b>Corpo inox escovado</b> brushed stainless steel structure	1800x220x81	124004
<b>Corpo inox escovado + placa acrílico branca</b> Brushed stainless steel structure + white acrylic sheet	1830x250x87	124012

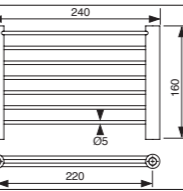

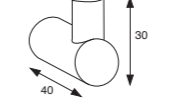
Planus →

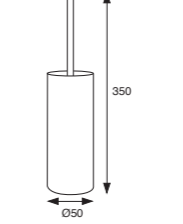
Planus			Cromado	Branco	Preto
		Toalheiro banheiro latão 565mm Towel rail 565mm	072340015651	072340015652	072340015653
		Toalheiro lavatório latão 415mm Towel rail 415mm	072340014001	072340014002	072340014003
		Toalheiro bidê latão 265mm Towel rail 265mm	072340012651	072340012652	072340012653
		Estante latão 500mm Shelf 500mm	072340015101	072340015102	072340015103
		Toalheiro bidê argola latão 250mm Towel ring 250mm	072340012501	072340012502	072340012503
		Saboneteira ba./Duche latão 240mm Soap dish 240mm	072340022401	072340022402	072340022403
		Saboneteira lavatório 120mm Basin soap dish 120mm	072340021201	072340021202	072340021203
		Porta rolos simples latão Toilet roll holder	072340031501	072340031502	072340031503
		Cabide latão Robe hook	0723400430351	0723400430352	0723400430353
		Porta piaçaba chão latão Toilet brush set	072340536011	072340536012	072340536013
		Porta piaçaba parede latão Wall toilet brush set	072340536021	072340536022	072340536023
		Prateleira vidro/latão cromado 420mm Shelf glass/chrome brass 420mm	072340067601	072340067602	072340067603
		Toalheiro de pé com 2 toalheiros latão Standing towel holder w/ 2 holders	072340067601	072340067602	072340067603

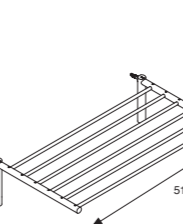
Minimal →

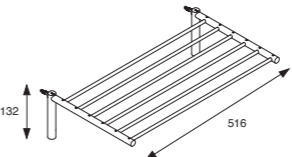
Minimal			Cromado	Branco	Preto
		Toalheiro banheiro latão 500mm Towel rail 500mm	072341015001	072341015002	072341015003
		Toalheiro lavatório latão 400mm Towel rail 400mm	072341014001	072341014002	072341014003
		Toalheiro bidê latão 250mm Towel rail 250mm	072341012501	072341012502	072341012503
		Porta rolos simples latão Toilet roll holder	072341031501	072341031502	072341031503
		Saboneteira banheiro/duche latão 240mm Soap dish 240mm	072341022401	072341022402	072341022403
		Cabide latão Robe hook	07234104601	07234104602	07234104603
		Porta piaçaba chão latão Toilet brush set	072341535011	072341535012	072341535013
		Porta piaçaba parede latão Wall toilet brush set	072341535021	072341535022	072341535023
		Toalheiro estante de hotelaria Hotel shelf towel rack	072341535021	072341535022	072341535023

## → CHARME CANTO →

P. 4

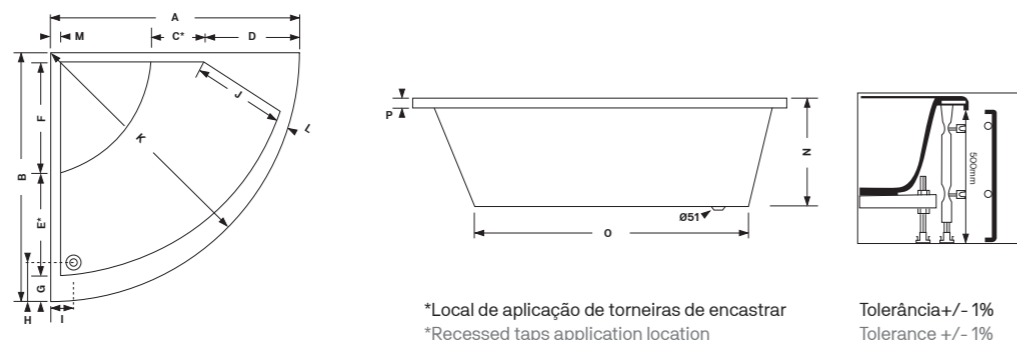

\*Local de aplicação de torneiras de encastrar  
\*Recessed taps application location

Tolerância +/- 1%  
Tolerance +/- 1%

Medida (mm)	Referência	A	B	C	D	E	F	G	H	I	J	K	L	M	N	O	P
1300x1300	06021710130130	1300	1300	360	545	560	490	160	290	210	460	1290	80	75	400	1000	50
1350x1350	06021710135135	1350	1350	380	560	600	510	160	325	215	510	1360	80	80	400	1050	50
1400x1400	06021710140140	1400	1400	410	560	580	560	160	315	200	535	1430	80	80	400	1140	50
1450x1450	06021710145145	1450	1450	430	575	600	590	160	325	215	560	1505	80	75	400	1200	50
1500x1500	06021710150150	1500	1500	450	540	550	700	165	300	200	555	1600	80	80	400	1280	50

Local de aplicação de torneiras de encastrar - Recessed tap application location

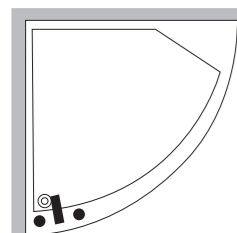

Esquema para Modelos:  
(1ª possibilidade)  
Layout for Models:  
(1st possibility)  
NASCENTE  
QUADRA  
SLIM  
CILINDRICA  
EXTRAPLANA

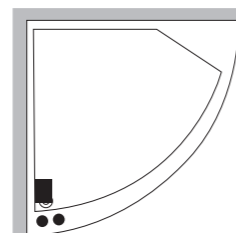

Esquema para Modelos:  
(2ª possibilidade)  
Layout for Models:  
(2nd possibility)  
EXTRAPLANA

Nota: Aconselhamos sempre a aplicação do conjunto anti-gotas nas torneiras de encastrar, para evitar, a tão indesejável entrada de água pelo orifício do suporte de chuveiro que se deposita na zona inferior da banheira. Este dispositivo permite drenar a água durante e depois do banho através do tubo flexível que liga o anti-gotas à válvula de descarga automática.

Note: We always recommend the application of the anti-drip set on the built-in taps, to prevent undesirable water entry through the hole in the shower support that is deposited in the lower area of the bathtub. This device makes it possible to drain the water during and after bathing through the flexible tube that connects the anti-drip valve to the automatic drain valve.

NORMA: NP EN 14516:2006 + A1 (2013)

## → CHARME

P. 8

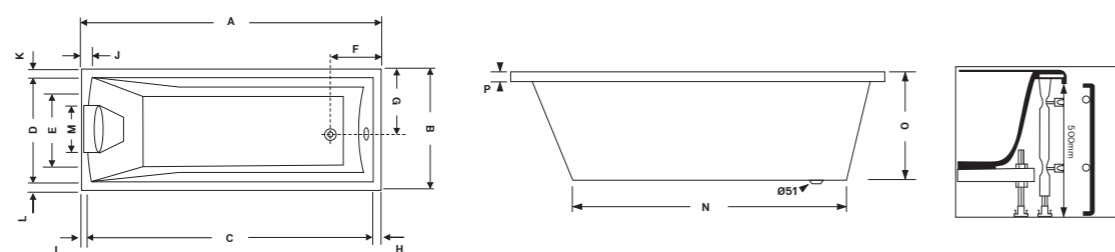

Tolerância +/- 1%  
Tolerance +/- 1%

Medida (mm)	Referência	A	B	C	D	E	F	G	H	I	J	K	L	M	N	O	P
1600x700	0601171016070	1600	700	1480	590	420	235	350	50	70	130	55	55	315	1070	410	50
1600x750	0601171016075	1600	750	1480	640	450	235	375	50	70	140	55	55	315	1070	410	50
1700x700	0601171017070	1700	700	1580	590	420	235	350	50	70	130	55	55	315	1170	410	50
1700x750	0601171017075	1700	750	1580	640	450	235	375	50	70	140	55	55	315	1170	410	50
1700x800	0601171017080	1700	800	1580	690	490	235	400	50	70	150	55	55	315	1170	410	50
1800x800	0601171018080	1800	800	1680	690	490	235	400	50	70	150	55	55	315	1270	410	50

NORMA: NP EN 14516:2006 + A1 (2013)

## → CLÁSSICA DUO →

P. 12

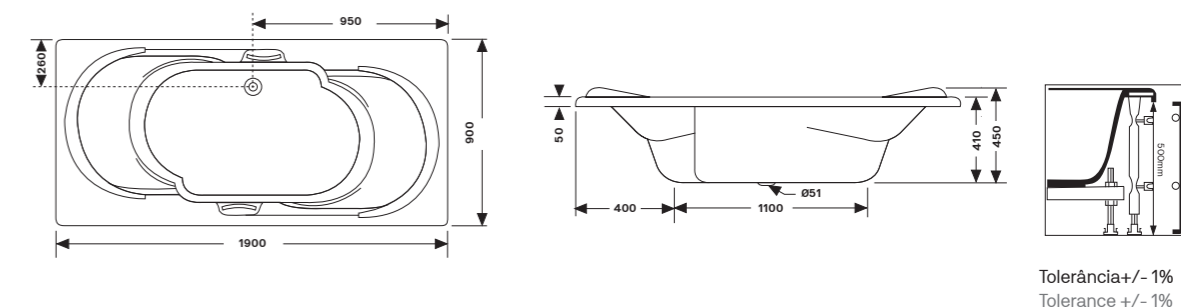

Tolerância +/- 1%  
Tolerance +/- 1%

NORMA: NP EN 14516:2006 + A1 (2013)

## → CLÁSSICA 1600 - 1800

P. 22

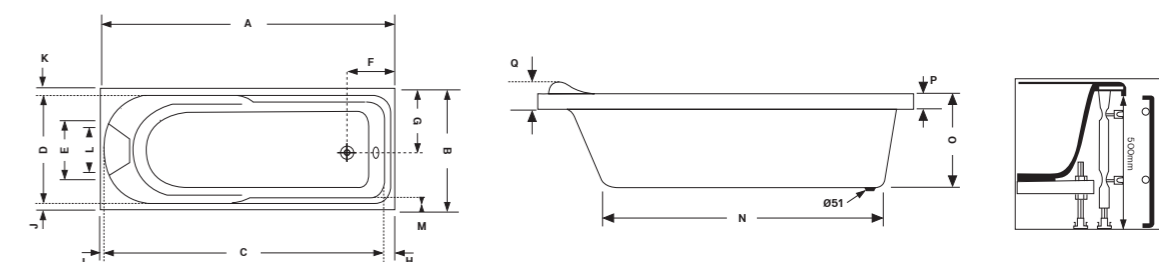

Tolerância +/- 1%  
Tolerance +/- 1%

Medida (mm)	Referência	A	B	C	D	E	F	G	H	I	J	K	L	M	N	O	P	Q
1600x700	0601161016070	1600	700	1400	560	390	230	350	75	40	70	40	345	100	1070	410	50	90
1600x750	0601161016075	1600	750	1400	590	420	230	375	75	40	80	40	345	110	1070	410	50	90
1700x700	0601161017070	1700	700	1580	560	390	230	350	75	40	70	40	345	100	1180	410	50	90
1700x750	0601161017075	1700	750	1585	590	420	230	375	75	40	80	40	345	110	1180	410	50	90
1700x800	0601161017080	1700	800	1585	630	440	230	400	75	40	80	40	345	120	1180	410	50	90
1800x800	0601161018080	1800	800	1680	630	440	230	400	75	40	80	40	345	120	1280	410	50	90

NORMA: NP EN 14516:2006 + A1 (2013)

## → CLÁSSICA 1400 - 1500

P. 20

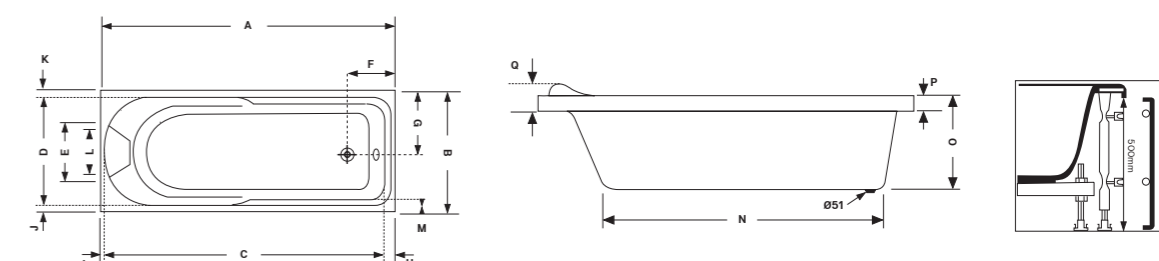

Tolerância +/- 1%  
Tolerance +/- 1%

Medida (mm)	Referência	A	B	C	D	E	F	G	H	I	J	K	L	M	N	O	P	Q
1400x700	0601161014070	1400	700	-	-	-	200	350	75	-	-	-	-	100	1000	410	50	90
1500x700	0601161015070	1500	700	-	-	-	200	350	75	-	-	-	-	100	1100	410	50	90

NORMA: NP EN 14516:2006 + A1 (2013)

## → CLÁSSICA 1200 →

P. 18

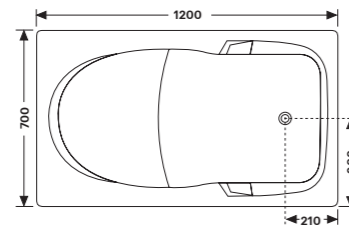

NORMA: NP EN 14516:2006 + A1 (2013)

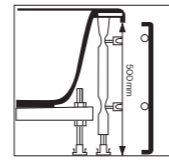
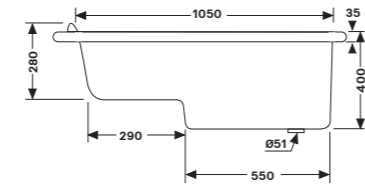

Tolerância+/- 1%  
Tolerance +/- 1%

## → CLÁSSICA 1350 →

P. 19

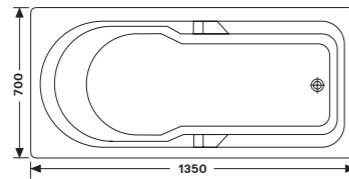

NORMA: NP EN 14516:2006 + A1 (2013)

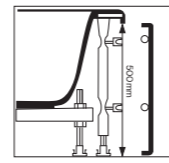
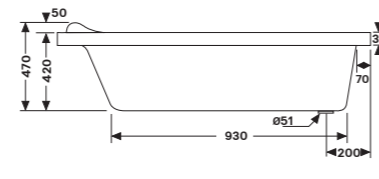

Tolerância+/- 1%  
Tolerance +/- 1%

## → PLANÍSSIMA CANTO

P. 24

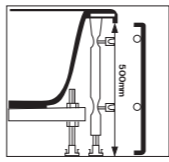
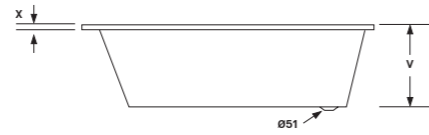
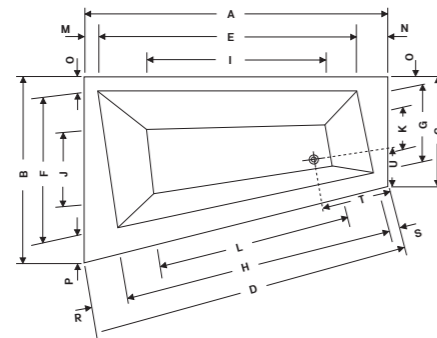

Tolerância+/- 1%  
Tolerance +/- 1%

Medida (mm)	Referência	A	B	C	D	E	F	G	H	I	J	K	L	M	N	O	P	Q	R	S	T	U	V	X
1600x1000x650	06021510160100D/E	1600	1000	650	1625	1350	780	465	1350	1080	580	360	1070	70	160	75	110	75	160	110	270	250	400	50
1700x1000x650	06021510170100D/E	1700	1000	650	1750	1470	795	465	1540	1180	660	405	1180	70	160	75	110	75	160	110	270	250	400	50
1700x1200x650	06021510170120D/E	1700	1200	650	1800	1470	965	465	1510	1200	800	435	1210	70	160	75	110	75	190	110	270	250	400	50
1800x1300x700	06021510180130D/E	1800	1300	700	1900	1560	1060	515	1595	1290	900	480	1300	70	170	75	110	75	205	110	270	250	400	50

### Local de aplicação de torneiras de encastrar - Recessed tap application location

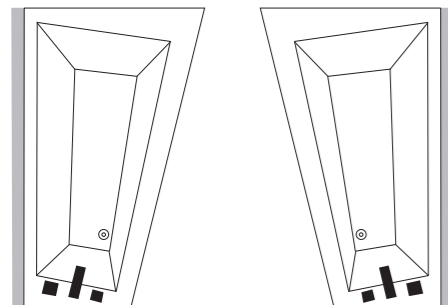

Esquema para Modelos:  
Layout for Models:  
NASCENTE  
QUADRA  
SLIM  
CILÍNDRICA  
EXTRAPLANA

Nota: Aconselhamos sempre a aplicação do conjunto anti-gotas nas torneiras de encastrar, para evitar, a tão indesejável entrada de água pelo orifício do suporte de chuveiro que se deposita na zona inferior da banheira. Este dispositivo permite drenar a água durante e depois do banho através do tubo flexível que liga o anti-gotas à válvula de descarga automática.

Note: We always recommend the application of the anti-drip set on the built-in taps, to prevent the so undesirable entry of water through the hole in the shower support that is deposited in the lower area of the bathtub. This device makes it possible to drain the water during and after bathing through the flexible tube that connects the anti-drip valve to the automatic drain valve.

NORMA: NP EN 14516:2006 + A1 (2013)

## → PLANÍSSIMA DUO

P. 30

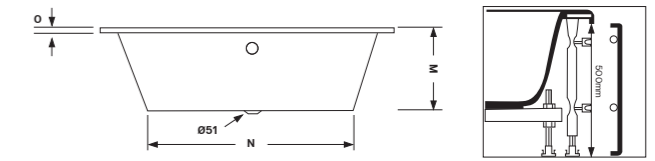
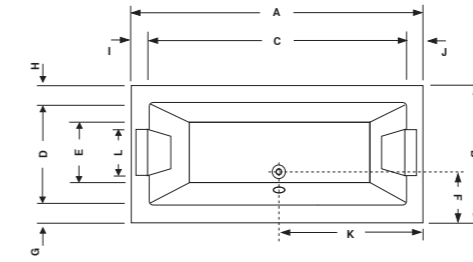

Tolerância+/- 1% - Tolerance +/- 1%

Medida (mm)	Referência	A	B	C	D	E	F	G	H	I	J	K	L	M	N	O
1800x800	0601151018080	1800	800	1590	620	500	250	90	130	105	105	900	315	400	1140	50
1800x900	0601151018090	1800	900	1590	720	600	250	90	75	105	105	900	315	400	1140	50
1900x800	0601151019080	1900	800	1690	620	500	250	90	75	105	105	950	315	400	1240	50
1900x900	0601151019090	1900	900	1690	720	600	250	90	75	105	105	950	315	400	1240	50
2000x1000	06011510200100	2000	1000	1790	820	700	250	90	75	105	105	1000	315	400	1340	50

### Local de aplicação de torneiras de encastrar - Recessed tap application location

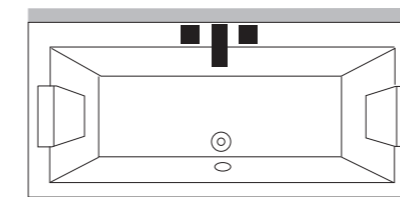

Esquema para Modelos:  
Layout for Models:  
NASCENTE  
QUADRA  
SLIM  
CILÍNDRICA  
EXTRAPLANA

Nota: Aconselhamos sempre a aplicação do conjunto anti-gotas nas torneiras de encastrar, para evitar, a tão indesejável entrada de água pelo orifício do suporte de chuveiro que se deposita na zona inferior da banheira. Este dispositivo permite drenar a água durante e depois do banho através do tubo flexível que liga o anti-gotas à válvula de descarga automática.

Note: We always recommend the application of the anti-drip set on the built-in taps, to prevent undesirable water entry through the hole in the shower support that is deposited in the lower area of the bathtub. This device makes it possible to drain the water during and after bathing through the flexible tube that connects the anti-drip valve to the automatic drain valve.

NORMA: NP EN 14516:2006 + A1 (2013)

## → PLANÍSSIMA

P. 34

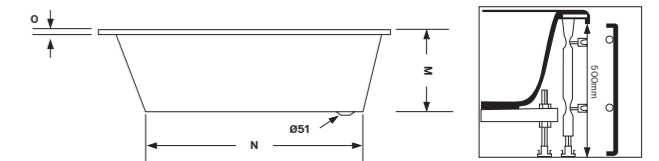
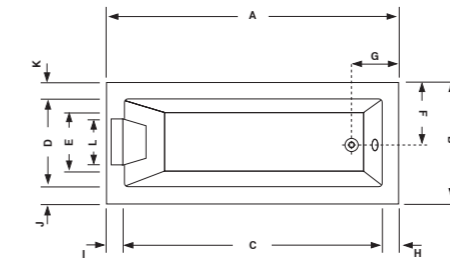

Tolerância+/- 1% - Tolerance +/- 1%

Medida (mm)	Referência	A	B	C	D	E	F	G	H	I	J	K	L	M	N	O
1500x700	0601151015070	1500	700	1330	530	410	350	230	75	95	85	85	315	400	1010	50
1600x700	0601151016070	1600	700	1430	530	410	350	230	75	95	85	85	315	400	1060	50
1600x750	0601151016075	1600	750	1430	560	450	375	230	75	95	85	95	315	400	1080	50
1700x700	0601151017070	1700	700	1530	530	410	350	230	75	95	85	85	315	400	1180	50
1700x750	0601151017075	1700	750	1530	560	450	375	250	75	95	95	95	315	400	1180	50
1700x800	0601151017080	1700	800	1520	590	470	400	230	75	105	105	105	315	400	1160	50
1800x750	0601151018075	1800	750	1620	560	450	375	230	75	105	95	95	315	400	1260	50
1800x800	0601151018080	1800	800	1620	590	470	400	230	75	105	105	105	315	400	1260	50
1900x900	0601151019090	1900	900	1720	690	520	450	230	75	105	105	105	315	400	1360	50
1900x1000	06011510190100	1900	1000	1720	790	600	500	230	75	105	105	105	315	400	1360	50

### Local de aplicação de torneiras de encastrar (apenas possível em banheiras 1700x800 1800x800 1900x900 1900x1000) Recessed tap application location (only possible in bathtubs 1700x800 1800x800 1900x900 1900x1000)

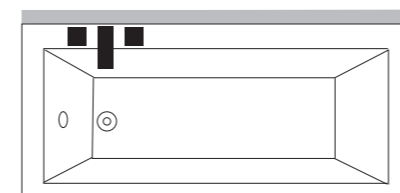

Esquema para Modelos:  
Layout for Models:  
NASCENTE  
QUADRA  
SLIM  
CILÍNDRICA  
EXTRAPLANA

Nota: Aconselhamos sempre a aplicação do conjunto anti-gotas nas torneiras de encastrar, para evitar, a tão indesejável entrada de água pelo orifício do suporte de chuveiro que se deposita na zona inferior da banheira. Este dispositivo permite drenar a água durante e depois do banho através do tubo flexível que liga o anti-gotas à válvula de descarga automática.

Note: We always recommend the application of the anti-drip set on the built-in taps, to prevent the so undesirable entry of water through the hole in the shower support that is deposited in the lower area of the bathtub. This device makes it possible to drain the water during and after bathing through the flexible tube that connects the anti-drip valve to the automatic drain valve.

NORMA: NP EN 14516:2006 + A1 (2013)



## → BECOOL

P. 66

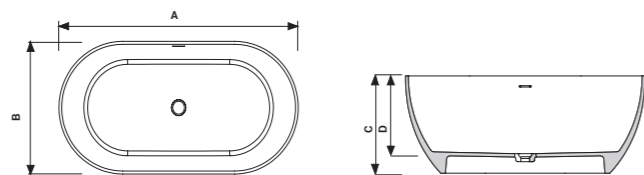

Tolerância +/- 1%  
Tolerance +/- 1%

Medida (mm)	Referência	A	B	C	D
1700x800	0605201017080	1700	800	540	430
1600x800	0605201016080	1600	800	540	430

## → OVAL

P. 68

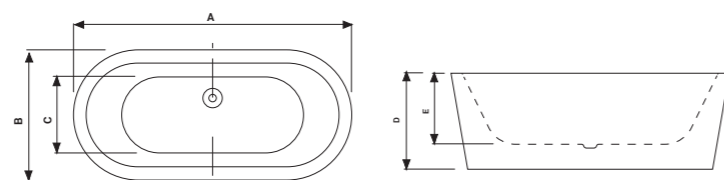

Tolerância +/- 1%  
Tolerance +/- 1%

Medida (mm)	Referência	A	B	C	D	E
1790x790	0605181017979	1790	790	480	580	430
1690x780	0605181016978	1690	780	470	530	410

## → TENDENCE

P. 70

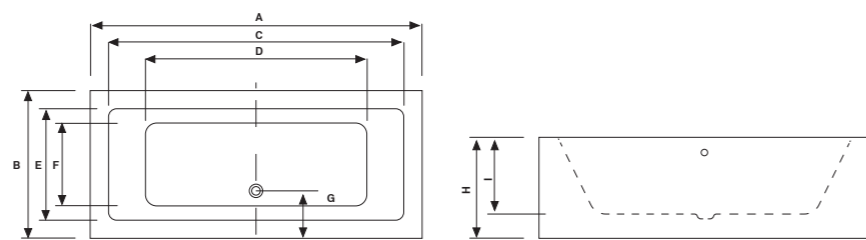

Tolerância +/- 1%  
Tolerance +/- 1%

Medida (mm)	Referência	A	B	C	D	E	F	G	H	I
1800x800	0605171018080	1800	800	1600	1200	600	450	260	550	430

## → ART EPOQUE

P. 72

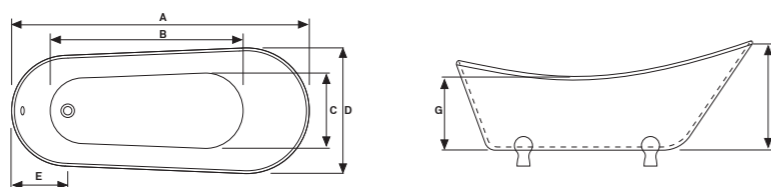

Tolerância +/- 1%  
Tolerance +/- 1%

Medida (mm)	Referência	A	B	C	D	E	G	F
1790x780	0605191017978	1750	1130	450	740	330	430	740

## → CASCATA 1800

P. 88

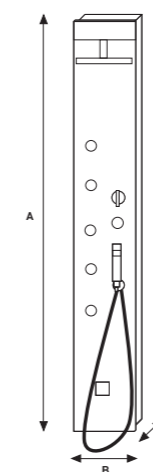

	A	B	C
<b>Corpo inox escovado</b> Brushed stainless steel structure	1800	220	81
<b>Corpo inox escovado + placa acrílico branca</b> Brushed stainless steel structure + white acrylic sheet	1830	250	87

## → CASCATA 1500

P. 88

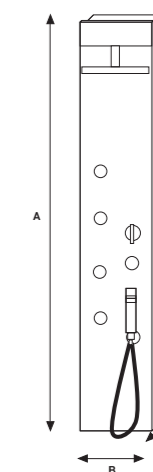

	A	B	C
<b>Corpo inox escovado</b> Brushed stainless steel structure	1550	220	81
<b>Corpo inox escovado + placa acrílico branca</b> Brushed stainless steel structure + white acrylic sheet	1530	250	87

## → INOX 2000

P. 90

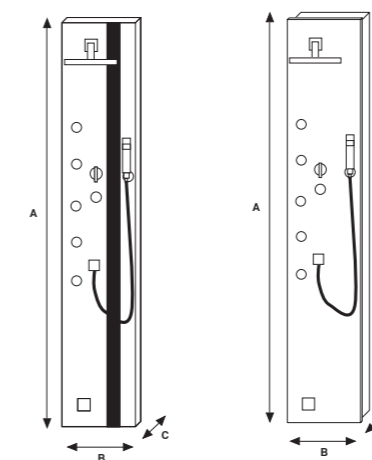

	A	B	C
<b>Corpo inox escovado + faixa de madeira</b> Brushed stainless steel structure	2000	330	81
<b>Corpo inox escovado + placa acrílico branca</b> Brushed stainless steel structure + white acrylic sheet	2030	350	87

## → INOX 1800

P. 92

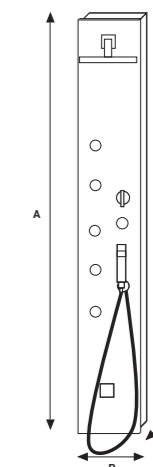

	A	B	C
<b>Corpo inox escovado</b> Brushed stainless steel structure	1800	220	81
<b>Corpo inox escovado + placa acrílico branca</b> Brushed stainless steel structure + white acrylic sheet	1830	250	87

## »» INOX 1500

P. 92

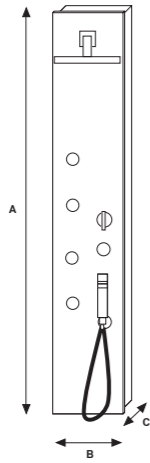

## »» INOX BANHEIRA

P. 94

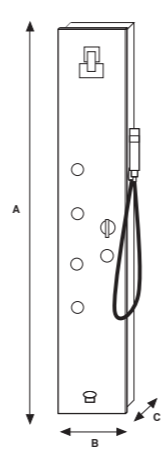

	A	B	C
<b>Corpo inox escovado</b> Brushed stainless steel structure	1500	220	81
<b>Corpo inox escovado + placa acrílica branca</b> Brushed stainless steel structure + white acrylic sheet	1530	250	87

	A	B	C
<b>Corpo inox escovado</b> Brushed stainless steel structure	1500	220	81
<b>Corpo inox escovado + placa acrílica branca</b> Brushed stainless steel structure + white acrylic sheet	1530	250	87

## »» ECO 1800

P. 96

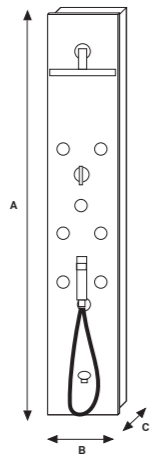

## »» ECO 1500

P. 96

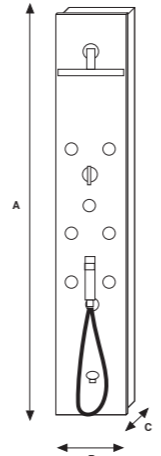

	A	B	C
<b>Corpo inox escovado + faixa de madeira</b> Brushed stainless steel structure	1800	220	81
<b>Corpo inox escovado + placa acrílica branca</b> Brushed stainless steel structure + white acrylic sheet	1830	250	87

	A	B	C
<b>Corpo inox escovado</b> Brushed stainless steel structure	1500	220	81
<b>Corpo inox escovado + placa acrílica branca</b> Brushed stainless steel structure + white acrylic sheet	1530	250	87

E-MAIL: [encomendas@asd.pt](mailto:encomendas@asd.pt)

CLIENTE | CUSTOMER

DATA | DATE

ENCOMENDADO POR | ORDER BY

BANHEIRA | BATHTUB

PLANÍSSIMA DUO

CLÁSSICA

CAMÉLIA ESQUERDA

QUANTIDADE | QUANTITY \_\_\_\_\_

PLANÍSSIMA CANTO ESQ. | LEFT

CLÁSSICA DUO

CAMÉLIA DIREITA

MEDIDA | MEASURE \_\_\_\_\_ x \_\_\_\_\_

PLANÍSSIMA CANTO DIR. | RIGHT

CHARME

ELEGANCE

PLANÍSSIMA

CHARME CANTO

TÍLIA

TULIPA

SISTEMAS DE HIDROMASSAGEM | WHIRLPOOL SYSTEMS

ECOLINE (6 jatos de água)  
ECOLINE (6 water jets)

ELETRÓNICO SIMPLES ABS (6 jatos de água)  
SIMPLE ELECTRONIC ABS (6 water jets)

ELETRÓNICO KOMBI ABS (6 jatos laterais+10 jatos inferiores)  
ELECTRONIC KOMBI ABS (6 lateral jets+10 lower jets)

PNEUMÁTICO SIMPLES ABS (6 jatos de água)  
SIMPLE PNEUMATIC ABS (6 water jets)

ELETRÓNICO DUPLO ABS (6 jatos de água+10 jatos ar)  
DOUBLE ELECTRONIC ABS (6 water jets+10 air jets)

ELETRÓNICO FLAT LATÃO (6 jatos de água+10 jatos ar)  
ELECTRONIC FLAT BRASS (6 water jets+10 air jets)

PNEUMÁTICO DUPLO ABS (6 jatos de água+10 jatos ar)  
DOUBLE PNEUMATIC ABS (6 water jets+10 air jets)

MICROJATOS | MICROJETS

OPÇÕES | OPTIONS

QUANTIDADE | QUANTITY \_\_\_\_\_

AROMATERAPIA  
AROMATHERAPY

JATOS DE PESCOÇO  
NECK JETS

COSTAS | BACK \_\_\_\_\_ PÉS | FEET \_\_\_\_\_

VÁLVULA DE ENCHIMENTO E DESCARGA AUTOMÁTICA  
POP-UP WASTE WITH OVERFLOW WATER OUTLET SPOUT

CADEIA DE LEDS  
LED SPA LIGHTS

Combinações possíveis: 3 costas+0 pés | 3 costas+2 pés | 5 costas+0 pés |  
5 costas +2 pés | na Clássica Duo, Elegance, Tília, Tulipa e Planíssima Duo: 2+2 ou 3+3  
Possible combinations: back 3+feet 0 | back 3+feet 2 | back 5 feet+0 | back 5+feet 2  
| in Clássica Duo, Elegance, Tília, Tulipa and Planíssima Duo: 2+2 or 3+3.

SISTEMA DE DESINFECÇÃO AUTOMÁTICA  
DISINFECTION SYSTEM

ENCOSTO PRETO  
BLACK HEADRES

CROMOTERAPIA  
CHROMOTHERAPY

TORNEIRA MODELO  
MIXERS MODEL

LÂMPADA DE IODO  
SPA LIGHT

PAINÉIS ACRÍLICOS | ACRYLIC PANEL

PAINÉIS MADEIRA | WOOD PANEL

FRONTAL  
FRONTAL \_\_\_\_\_ x \_\_\_\_\_

FRONTAL  
FRONTAL \_\_\_\_\_ x \_\_\_\_\_

FENÓLICO  
PHENOLIC

ENVERNIZADO  
VARNISHED

LACADOS  
LACQUERED

LATERAL ESQ.  
LEFT LATERAL \_\_\_\_\_ x \_\_\_\_\_

LATERAL  
LATERAL \_\_\_\_\_ x \_\_\_\_\_

CASTANHO  
BROWN

CASTANHO  
BROWN

VERDE  
GREEN

VIOLETA  
VIOLET

LATERAL DIR.  
RIGHT LATERAL \_\_\_\_\_ x \_\_\_\_\_

LATERAL  
LATERAL \_\_\_\_\_ x \_\_\_\_\_

FAIA  
BEECH

FAIA  
BEECH

LARANJA  
ORANGE

GRAFITE  
GRAPHIT

CANTO  
CORNER

MEL  
HONEY

MEL  
HONEY

RUBI  
RUBY

BRANCO  
WHITE

CANTO COM DEGRAU  
CORNER WITH STEP

WENGUÉ  
WENGUE

WENGUÉ  
WENGUE

PRETO  
BLACK

LOCALIZAÇÃO DO MOTOR - SITE OF PUMP  
BANHEIRAS RETANGULARES - RECTANGULAR BATHTUBS

BANHEIRAS DE CANTO  
CORNER BATHTUBS

CLÁSSICA, CHARME, PLANÍSSIMA

PLANÍSSIMA DUO, CLÁSSICA DUO

CHARME CANTO

TULIPA, TÍLIA, ELEGANCE

PLANÍSSIMA CANTO  
ESQUERDA

PLANÍSSIMA CANTO  
DIREITA

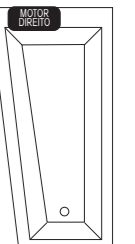
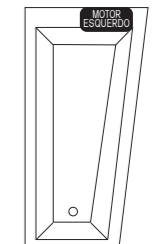
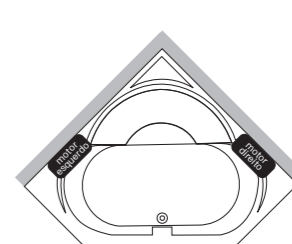
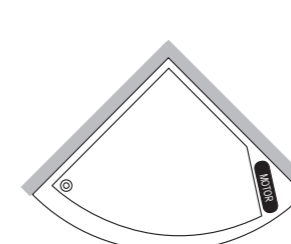
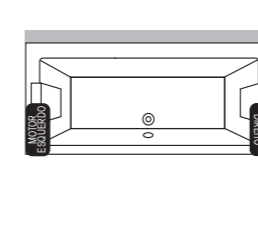
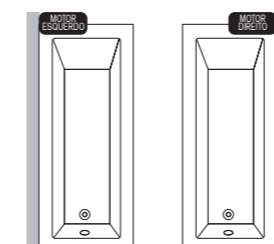



Declaração de conformidade → Declaration of conformity 

Declara-se que o produto: | Declares that the product:

Descrição: | Description:

Banheira de hidromassagem | Whirlpool bathtub

Marca: | Brand:

ASD®

Variantes: | Variant:

Clássica, Clássica Duo, Charme, Charme Canto, Planíssima, Planíssima Duo, Planíssima Canto, Gardénia, Elegance, Tília, Tulipa e Camélia

Variantes de sistemas de hidromassagem:

Ecoline ABS, Pneumático Simples ABS, Pneumático Duplo ABS, Eletrónico Simples ABS, Eletrónico Duplo ABS, Eletrónico Kombi ABS, Eletrónico Duplo Flat Latão.

Whirlpool systems variants:

Ecoline ABS, Simple Pneumatic ABS, Double Pneumatic ABS, Simple Electronic ABS, Double Electronic ABS, Kombi Electronic ABS, Double Electronic Flat Brass.

Fabricado por: | Manufactured by:

A.S.D. - Soluções de banho, S.A.

Rua Francisco Reis 284, Serém de Cima

3750-599 Macinhata do Vouga - Águeda - Portugal

Está em conformidade com os requisitos essenciais de segurança da Diretiva

In accordance with the essential safety requirements of Directive

**2006/95/CE**

“Harmonização das legislações dos Estados Membros no domínio do material elétrico destinado a ser utilizado dentro de certos limites de tensão.”

“Harmonisation of the laws of Member States relating to electrical equipment designed for use within certain voltage limits”

A conformidade com os requisitos essenciais de segurança da Diretiva foi confirmada pela realização de ensaio no Laboratório de ensaios do LIQ, tendo sido emitido o Relatório de Ensaio N° 060/13 de 2014-02-11 segundo as normas EN 60335-1:2002 + A1:2004 + A11:2004 + A12:2006 + A2:2006 + A13:2008 e EN 60335-2-60:2013 + A1:2005 + A2:2008 + A11:2010 + A12:2010. O presente Relatório de Conformidade é emitido com base no disposto no n° 2 do artigo 8° da Diretiva 2006/95/CE.

The conformity with the safety requirements of Directive was confirmed by the performance of tests in the LIQ testing laboratory, and was issued the Test Report N° 060/13 from 2014-02-11 according to the norms EN 60335-1:2002 + A1:2004 + A11:2004 + A12:2006 + A2:2006 + A13:2008 and EN 60335-2-60:2013 + A1:2005 + A2:2008 + A11:2010 + A12:2010. The Compliance Report is issued under paragraph 2 of Article 8 of Directive 2006/95/EC.



**LIQ** Laboratório Industrial da Qualidade

Produtos fabricados em Portugal pela ASD, S.A. - Products manufactured in Portugal by ASD, S.A.

Declaração de conformidade → Declaration of conformity 

De acordo com o regulamento (EU) N° 305/2011 do Parlamento Europeu e do Conselho que estabelece as condições de harmonização para a comercialização dos produtos de construção.

According to regulation (EU) N° 305/2011 of European Parliament and the Council that laying down the conditions of harmonisation for the marketing of construction products.

A, A.S.D. - Soluções de banho, S.A.

Rua Francisco Reis 284, Serém de Cima

3750-599 Macinhata do Vouga - Águeda - Portugal

Declara sob sua responsabilidade a conformidade das Bases de Chuveiro e Banheiras Acrílicas com a NP EN 14516:2006+A1:2013: “Shower trays for domestic purposes; NP EN 14527:2006+A1:2013: Baths for domestic purposes e Anexo ZA” das Normas Europeias harmonizadas.

Declare under our responsibility the conformity of Acrylic Bathtubs and Shower trays with NP EN 14516:2006+A1:2013: “Shower trays for domestic purposes;

NP EN 14257:2006+A1:2013: Baths for domestic purposes and Anexo ZA” of the harmonized European Standards.

PRODUTO   PRODUCT	MODELO   MODEL	MEDIDA   MEASURE	COR   COLOR
Banheira Retangular	Clássica	1200/1350/1400/1500...700	Branco
Banheira Retangular	Clássica	1600/1700...700/750	Branco
Banheira Retangular	Clássica	1700/1800...800	Branco
Banheira Retangular	Planíssima	1500/1600/1700/1800...700/750	Branco
Banheira Retangular	Planíssima	1700/1800/1900...800/900/1000	Branco
Banheira Retangular	Planíssima Duo	1800/1900...800/900	Branco
Banheira Retangular	Planíssima Duo	2000...1000	Branco
Banheira Retangular	Charme	1600/1700...700/750	Branco
Banheira Retangular	Charme	1700/1800...800	Branco
Banheira Retangular	Clássica Duo	1900...900	Branco
Banheira Canto	Gardénia	1200...1200	Branco
Banheira Canto	Charme	1300...1300/1350...1350/1400...1400/1450...1450/1500...1500	Branco
Banheira Canto	Planíssima esquerda/direita	1600...1000/1700...1000/1200/1800...1300	Branco
Banheira Canto	Elegance	1500...1500	Branco
Banheira Canto	Tília	1450...1450	Branco
Banheira Canto	Tulipa	1400...1400	Branco
Banheira Canto	Camélia esq/dir	1580...1030	Branco

Produtos fabricados em Portugal pela ASD, S.A. - Products manufactured in Portugal by ASD, S.A.

## Condições gerais de venda → Purchase/sale conditions

### Encomendas

Todas as encomendas são válidas mediante a confirmação da ASD - Soluções de Banho S.A.

As encomendas podem ser parcialmente executadas e os preços de venda, bem como as condições gerais de venda são aquelas que se tornam válidas no momento da aprovação.

### Prazo de entrega

Os prazos de entrega são meramente indicativos, não são obrigatórios e em nenhum caso podem ser utilizados para justificar atrasos de pagamento e compensação por danos.

Na entrega da mercadoria através de empresa de transporte os custos dos portes serão suportados pela ASD, S.A. para faturas superiores a 1000euros.

### Preços

Embalagem especial para exportação (caixa fechada + palete) sofre um acréscimo de 20€ por embalagem. Os preços praticados são os constantes na tabela de preços em vigor no momento da expedição da mercadoria. Os preços constantes na tabela estão em euros, não incluem IVA e podem ser alterados sem aviso prévio. A presente tabela de preços anula e substitui as anteriores.

### Devoluções e reclamações

O consignatário tem de verificar os bens no ato de entrega e comunicar qualquer anomalia verificada no momento da entrega.

As reclamações sobre o estado do produto são consideradas válidas quando comunicadas no prazo máximo de 8 dias a contar da data da entrega.

Apenas se aceitam devoluções de produtos embalados na sua caixa original e após aceitação da ASD, S.A. Em caso de devolução a mercadoria deverá ser acompanhada pela respetiva nota de devolução, indicando o documento de venda que lhe deu origem. Não se aceitam devoluções de bases de duche da série PLANSTONE, de cores ou medidas fabricadas especialmente por encomenda. Na devolução de bases standard da série PLANSTONE (branco/antracite e medidas tabela) com caixas em mau estado procederemos ao débito de 15€ por caixa.

### Termos de pagamento

As condições de pagamento são as que constam na fatura, quando não vigorar outro tipo de acordo.

Em caso de atraso total ou parcial de pagamento, a ASD, S.A. tem direito a receber juros de mora, à taxa máxima legal em vigor e reserva-se o direito de suspender o fornecimento de material.

### Condições de pagamento

Desconto comercial acordado entre ASD, S.A. e o cliente.

### Condições gerais de venda

As condições gerais de venda são consideradas aceites no momento da encomenda.

AASD,S.A. tem o direito de implementar qualquer alteração nas suas condições, que seja considerada apropriada ou necessária por razões técnicas ou comerciais.

Sempre que necessário será feita referência ao código civil português. Em caso de litígio ambas as partes se submetem à jurisdição da comarca de Águeda.

### Purchase /orders

All orders are valid only following to ASD - Soluções de Banho S.A. approval.

The orders can be partial dispatched and the applicable selling prices and the applicable general sales conditions are the ones valid at the time of the approval.

### Delivery lead-time

Delivery times are indicative only and not mandatory and in no case can be as a plausible excuse for payment delays or for damages compensation.

In deliveries of goods by Transport Company the cost will be supported by ASD, S.A. if the invoice amount exceeds 1000euros.

### Prices

Special packaging for export (box + pallet) suffers an increase of 20€ per package.

The practiced prices are the constant ones in the price list in the moment of the merchandise expedition.

The prices are in Euros, do not include Taxes and can be modified at short notice.

The present price list cancels and substitutes the previous ones.

### Devolutions and complains

The consignee is asked to check the goods when delivered and claim any anomaly in the delivery moment. Claims are considered valid only when communicated by writing no later than 8 days from the delivery date of goods.

Returns are only accept when the products are packed in their original box and after acceptance of ASD, S.A. In case of returning, the goods must be accompanied by their note of return, indicating the original sales document. Not accept returns of shower trays PLANSTONE and series colors or measures designed specifically to order. In the standard shower trays returns of PLANSTONE or series (white/antracite and measures present in the price list) with boxes in poor condition we will proceed at a rate of €15 per box.

### Payment terms

Payments conditions are those listed in the commercial invoice, when not otherwise agreed.

In case of total or partial delay payment ASD, S.A. is entitled to charge interests to the legal maximum tax used at the time, and the right is reserved of suspending the supply of material.

### Payment conditions

Commercial discount agreed between ASD, S.A. and the customer.

### General sales conditions

The general sales conditions are considered fully accepted following to the purchase order issue.

ASD, S.A. is entitled to implement any change in its own items, which is deem appropriate or necessary for technical or commercial reasons.

When the context otherwise requires reference is made to the Portugal civil code. For any dispute, controversy or claim arising out of relating to these sales conditions shall be finally settled by the competent court in Águeda (Portugal).

### Importante

Os produtos apresentados no presente catálogo seguem especificações técnicas internas da ASD, S.A. baseadas nas normas internacionais em vigor.

Todas as medidas são apresentadas em milímetros. Tolerância + ou - 5%.

Os dados e as características indicadas no presente catálogo não obrigam a ASD, S.A. que se reserva o direito de efetuar todas as modificações nos componentes, materiais, referências e dados técnicos, sem aviso prévio ou imposição de substituição de produto.

A reprodução fotográfica da tonalidade de cores e cromática ou forma poderá não ser totalmente fiel à realidade.

Alguns acessórios presentes nos ambientes fotografados podem não estar para venda e/ou a ASD, S.A. não ser responsável pela sua venda.

### CUIDADOS PÓS-VENDA:

Antes de abrir a embalagem verificar cor, tamanho e modelo do produto adquirido.

Nas bases PLANSTONE, ao abrir a embalagem não arrastar a tampa sobre a superfície da base para não a riscar ou danificar com os parafusos.

Aconselhamos a desapertar os parafusos na totalidade e retirá-los da tampa.

Antes da aplicação ler cuidadosamente as instruções de montagem da base duche e da válvula e dos painéis de parede.

Inspeccione a base de chuveiro quanto a possíveis danos que possam ter ocorrido durante o transporte.

Não instale se houver algum dano visível.

### Important

The products listed in this catalog follow internal technical specifications of the ASD S.A. based on actual international standards.

All measurements are given in millimeters. Tolerance + or - 5%.

The data and the characteristics listed in this catalog doesn't oblige ASD, S.A. that reserves the right to make changes in all components, materials, references and technical data without notice or imposition of product substitution.

The photographic reproduction of tone colors or shape may not be totally true to reality.

Some accessories presented in the environment photographed are not for sale and/ or ASD, S.A. is not responsible for its sale.

### AFTER SALES CARE:

Before opening the package, check the color, size and model of the purchased product.

On PLANSTONE shower trays, when opening the packaging, do not drag the cover over the surface of the shower tray to avoid scratching or damaging it with the screws. We advise you to completely loosen the screws and remove them from the cover.

Before application, carefully read the installation instructions for the shower tray, the valve and the wall panels. Inspect the shower tray for any potential damage that may have occurred during transport.

Do not install if any damage is visible.

A.S.D. - Soluções de banho S.A.

**Norte - Sede e Showroom**

Rua Francisco Reis, 284 Serém Cima  
3750-599 Macinhata do Vouga - ÁGUEDA  
T: + 351 234 529 330

**Sul - Armazém e Showroom**

Zona Industrial da Tavagueira,  
Armazém Q n.º 12 8200-425 Guia  
T: + 351 289 561 512



**asd**  
Banho

*for You by ASD.*